



YASKAWA

# YASKAWA AC Drive Compact V/f Control Drive J1000

100 V CLASS, SINGLE-PHASE INPUT: 0.1 to 1.1 kW  
200 V CLASS, THREE-PHASE INPUT: 0.1 to 5.5 kW  
200 V CLASS, SINGLE-PHASE INPUT: 0.1 to 2.2 kW  
400 V CLASS, THREE-PHASE INPUT: 0.2 to 5.5 kW



Reliable and Smart



Certified for  
ISO9001 and  
ISO14001



JQA-0422



JQA-EM0498

# Reliable

Small but Reliable



# Smart

Easy to Operate  
and So Compact



YASKAWA AC Drive  
**J1000**  
Compact V/f Control Drive



Reliability the world has come to expect from Yaskawa as a global leader is now packed into an even smaller, more powerful unit.

So easy to use: just switch it on and you're ready to go.

J1000 is fully capable of efficient performance and energy saving, handling variable speed needs in compact applications.

A drive that exemplifies true world quality with a difference you can really feel.

## CONTENTS

- 04 Features
- 08 Application Benefits
- 10 Software Functions
- 12 Parameter List
- 14 Basic Instructions
- 16 Product Lineup
- 17 Model Selection
- 18 Standard Specifications
- 20 Standard Connection Diagram
- 22 Dimensions
- 24 Drive Watts Loss Data
- 26 Peripheral Devices and Options
- 41 Application Notes
- 46 YASKAWA AC Drive Series
- 47 Global Service Network

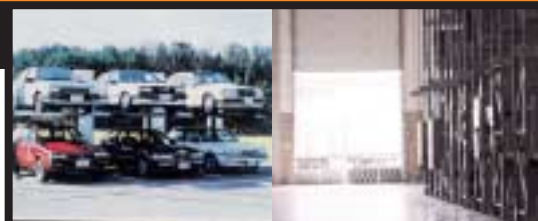

## Features

# 1.

# Fully Equipped with User and Environmentally-Friendly Functions

## Compact Design

Every drive has dual rating, Normal Duty (ND) and Heavy Duty (HD). Parameter settings let the user select the rating that best suits the application needs. Selecting ND allows the drive to operate a more powerful motor an entire frame size larger than with HD. Side-by-Side installation and J1000's impressively compact design make it possible to fit the entire setup into a the narrowest enclosures.

Note: Certain applications may require load reduction for proper performance. Select a motor that has a current rating within the rated current of the drive.

### ● How Side-by-Side Installation Works

Example: 200 V 0.75 kW

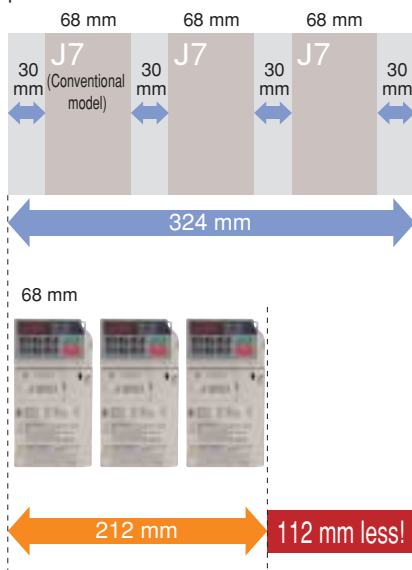

Note: Only 2 mm needed between J1000 drives. If the last drive in a series is installed next to a wall, a 30 mm gap is required.

Use J1000's slender Finless Type for an even more compact installation. Options also include an easy-to-connect NEMA 1 Type 1 kit to provide the protection the drive needs.

### ● Compact Setup in Enclosure Panel

Example: J1000 200 V Class, Three-Phase Input 3.7 kW (HD)

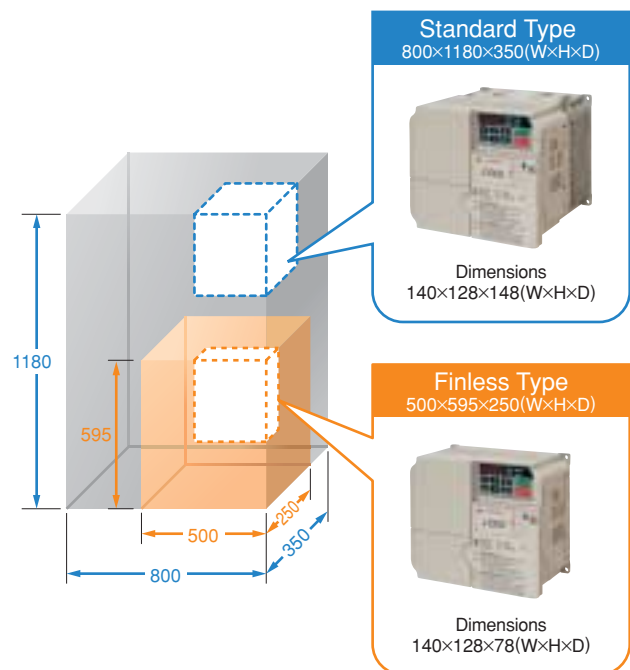

Note: As the Finless Type lacks its own heatsink, steps still need to be taken to ensure proper heat dissipation. The example above shows a drive installed to self-cooling, fully-enclosed panel. An external cooling unit has been added to handle cooling requirements. Refer to the manual for details.

## Easy Operation

The Setup Mode gives the user quick access to the basic parameters needed to get the application running right away. This feature ensures quick and easy setup once the drive is installed.

### ● Verify Menu

Parameters changed from their default values

Name	No.	Default	Set Value
Frequency Reference Selection 1	b1-01	1	0
Acceleration Time 1	C1-01	10.00 s	15.00 s
Deceleration Time 1	C1-02	10.00 s	15.00 s
⋮	⋮	⋮	⋮



## Environmentally Friendly

J1000 is fully compliant with EU's RoHS.



J1000 also offers Swing PWM to suppress motor noise for a more peaceful work environment.

### ● Acoustic Noise Levels from Swing PWM vs. Conventional PWM

**23.3% less**

Note: Calculated by analyzing noise generation and comparing peak values.

Features  
**2.**

## Ensuring Stable Operation

### Starts Heavy Loads Effortlessly

Fully automatic torque compensation across the entire speed range, whether accelerating, decelerating, or operating at constant speed. Capable of 100% rated torque as low as 1.5 Hz, and 150% at 3 Hz when set for Heavy Duty performance.

● **Powerful Torque**

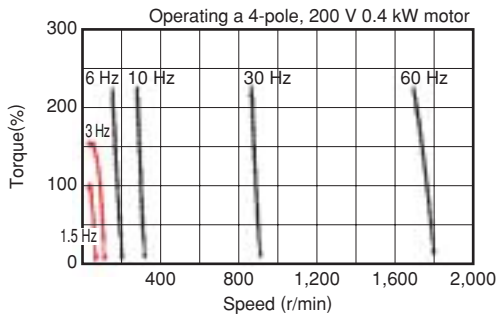

● **Yaskawa's Full Range, Fully Automatic Torque Compensation**

The drive output voltage needed in a single application varies with changing load conditions. Yaskawa's torque compensation function automatically adjusts voltage levels to maintain the required V/f pattern during acceleration, deceleration, and when operating at a constant speed.

### Smooth, Continuous Operation

Stall Prevention keeps the motor running smoothly. Speed Search and Momentary Power Loss Ride-Thru functions can restart a coasting motor without bringing the application to stop, making continuous operation possible should a transient fault occur.

● **Speed Search Method**

Easily restart the motor without cumbersome speed sensors. Perfect for fan, blowers, and other rotating, fluid-type applications.

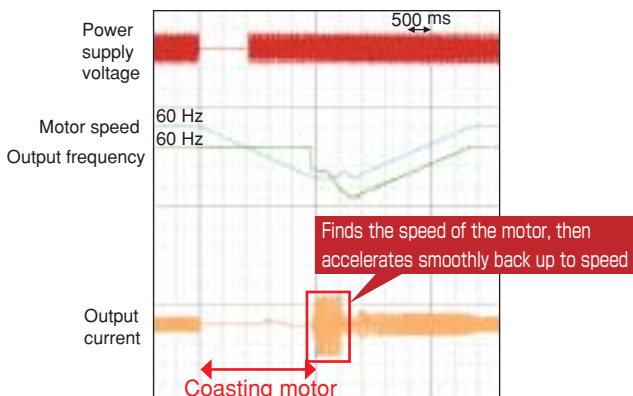

### Enhanced Braking

The overexcitation braking functions enables rapid braking up to 50% faster without using a braking resistor. All models come equipped with a braking transistor for even faster stopping capabilities should the user decide to install a braking resistor.

● **Overexcitation Braking**

※: Overexcitation braking for a 400 V class 3.7 kW drive without a braking resistor. Results may vary with motor and load conditions.

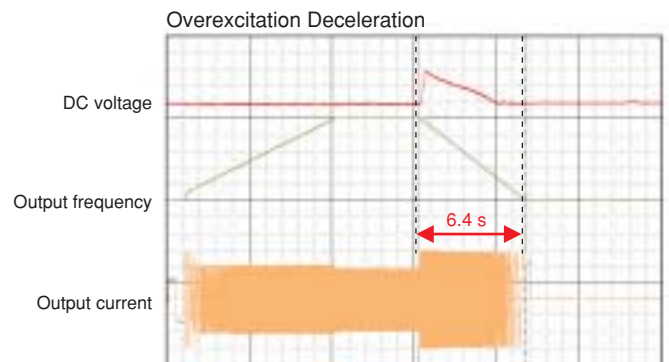
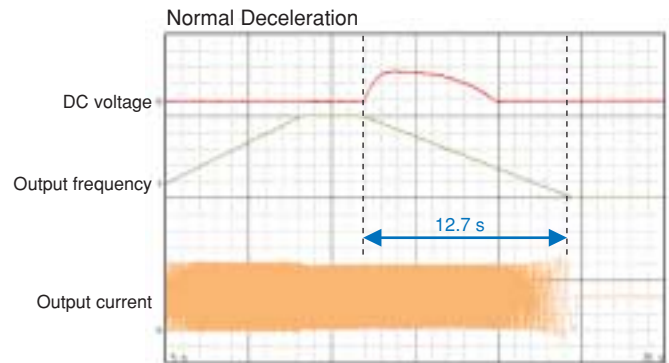

**50% faster!**

### Loaded with Protective Features

All models come equipped with an inrush current suppression circuit, protecting the drive from unstable power conditions. Overload detection and motor thermal protection prevent damage to connected machinery, while fault restart ensures continuous production.

## Features

### 3.

## True Reliability and Top Quality Assurance

### Hassle-free Maintenance

Yaskawa drives have a built-in maintenance timer that keeps track of component performance, including capacitors, soft-charge circuitry, IGBTs, and the cooling fan. This ensures maximum performance life of the drive.

The cooling fan is also designed for quick replacement: both detachable and easily accessible from the top of the drive.

#### ● Attaching/Detaching the Cooling Fan



Engineering tool DriveWizard Plus\*1 automatically converts parameter settings from the earlier VS mini J7 to match parameters in J1000.

Not only useful for model upgrades and transitions, but also a time-saving feature in case a drive needs to be replaced.

#### ● Model Transition

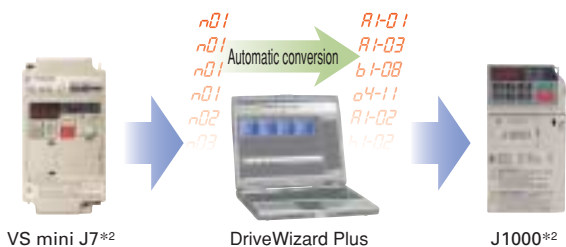

\*1: Available for download free of charge at [www.e-mechatronics.com](http://www.e-mechatronics.com).  
\*2: Requires an optional interface unit.

### Durability in a Wide Range of Environments

A wide range of protective features are available for harsher environments, including designs that are resistant to moisture, dust, oil, and shock.

### Convenient Parameter Management

Yaskawa's USB Copy Unit is available for applications with multiple drives requiring the same parameter settings. Use the Copy Unit to load parameters from the drive at the factory and edit them later on a PC\*3. Incredibly useful for backing up parameter settings and easier than a carrying around a laptop.

\*3: Requires an optional interface unit.

#### ● Centralized Management

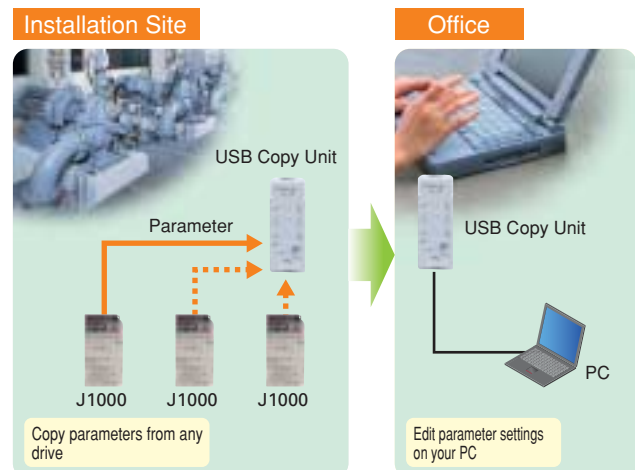

Note: USB Copy Unit designed to store parameters for a single drive.

#### ● Get Larger Applications Ready in No Time

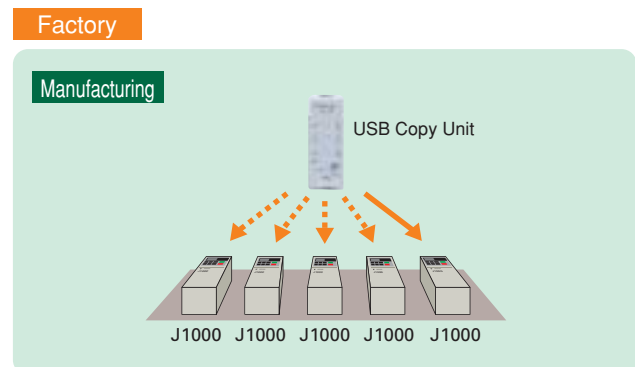

Note: Data can only be transferred between drives that are the same model running the same software version.

### Minimizing Power Supply Harmonics

AC and DC reactor are both available to minimize the amount of harmonic distortion in the system.

Features  
**4.**

## Wide Range of Options Available

### Compatible with a Single-Phase, 100 V Power Supply Information available soon

Yaskawa offers J1000 for both industry and home use with the availability of a single-phase 100 V model.

- Operate from Household Line Power

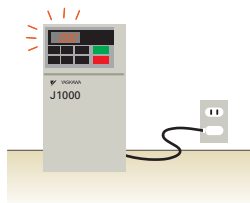

### Potentiometer Option Unit (option) Available soon

A speed potentiometer lets the user adjust the frequency simply by turning a dial. This optional potentiometer offers an easy way to control motor speed on the fly, without needing to access parameter settings.

- Potentiometer Option Unit



### LED Operator\*1 (option) Available soon

The LED operator allows the user to control the drive from up to 3 meters away, saving the hassle of directly accessing the drive when mounted inside an enclosure panel.

\*1: Requires an optional interface unit.

- Using the LED Operator

- View, edit, and set parameters
- Run/Stop
- Verify and copy parameter settings
- Monitor operation status

- Connecting the LED Operator

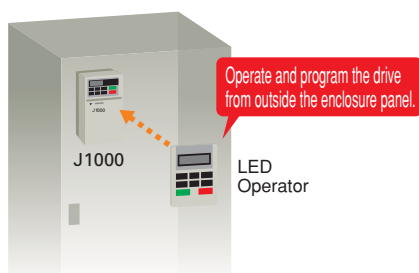

### DriveWizard Plus\*2

DriveWizard Plus makes it possible to operate the drive and perform maintenance using a PC. It has never been easier to edit parameters, access all monitors, create customized operation sequences, and observe drive performance with the oscilloscope function.

\*2: Download free of charge at [www.e-mechatronics.com](http://www.e-mechatronics.com).



- Parameter Editing

View and edit drive parameters.



- Oscilloscope Function

Displays operation status and drive performance in real time.



### RS-422/485 Interface for MEMOBUS communication (option)

Supports the MEMOBUS/Modbus protocol. Requires an optional interface.

### Built-in EMC Filter (option)

Available with a noise filter to meet European standards.

### Compliant with Global Product Standards

Compliance with global product regulations including CE, UL, and cUL makes J1000 fit for use worldwide.



# Application Benefits

J1000 gets the most out of the application.



## Fluid Applications

### Advantages

- 1 The Setup Mode saves valuable installation time by providing just the essential parameters needed to get the application running immediately.
- 2 Normal Duty keeps the cost of the application down by allowing the use of a larger motor.
- 3 Speed Search prevents loss from down time by keeping the application running smoothly through a power loss.
- 4 Prohibit reverse rotation with a single parameter setting to prevent improper operation and possible machine damage.
- 5 Swing PWM minimizes noise and leakage current, quieting undesirable motor noise.
- 6 Self-diagnostic features check the drive when a fault occurs. Automatic fault restart keeps the application running without needing to stop the motor, avoiding production loss from down time.
- 7 Verify Menu list any parameters that have been changed from their original default settings for easy maintenance and inspection.
- 8 Monitors display total operation time of various components. Extremely helpful in drive maintenance, offering performance life information for the cooling fan, main circuit capacitors, and other components that may eventually need replacement. A true time saver that allows the user to know exactly when replacements are needed so that the application never shuts down to due to component wear or failure.

### Functions

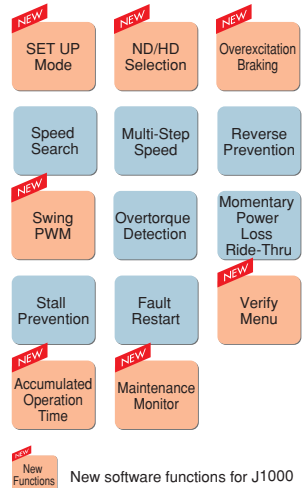

New Functions New software functions for J1000

### Applications



Fan



Pump



Compressor





## Conveyor, Transport, and Civil Applications

### Advantages

- 1 The Setup Mode saves valuable installation time by providing just the essential parameters needed to get the application running immediately.
- 2 Heavy Duty provides high overload capability for reliable operation without production loss from down time.
- 3 Overexcitation provides increased braking torque without the need for a braking resistor, keeping the installation compact and the cost low. If even more braking torque is needed, an additional braking resistor can be connected to the built-in braking transistor.
- 4 Swing PWM minimizes noise and leakage current, quieting disturbing motor noise.
- 5 Torque compensation features operate across the entire speed range to automatically provide just the right amount of torque whenever needed. Perfect for starting the toughest loads in the harshest conditions.
- 6 Self-diagnosis features check the drive when a fault occurs. Automatic fault restart keeps the application running without needing to stop the motor, avoiding production loss from down time.
- 7 Verify Menu lists any parameters that have been changed from their original default settings for easy maintenance and inspection.
- 8 Monitors display total operation time of various components. Extremely helpful in drive maintenance, offering performance life information for the cooling fan, main circuit capacitors, and other components that may eventually need replacement. A true time saver that allows the user to know exactly when replacements are needed so that the application never shuts down to due to component wear or failure.

### Functions

<b>NEW</b> SET UP Mode	<b>NEW</b> ND/HD Selection	<b>NEW</b> Overexcitation Braking
S-Curve Time	Multi-Step Speed	<b>NEW</b> Swing PWM
Torque Boost	Stall Prevention	Fault Restart
<b>NEW</b> Verify Menu	<b>NEW</b> Accumulated Operation Time	<b>NEW</b> Maintenance Monitor

**NEW** New Functions      New software functions for J1000

### Applications

 Conveyor	 Auto Shutter	 Automatic Doors
 Food & Beverage	 Agricultural	 Health & Leisure

# Software Functions

Loaded with software functions just right for your application.



New software available to upgrade from J7 to J1000, automatically matching function and sequence settings.

Note: Major functions listed below.

## Setup

NEW

### SET UP Mode

**Easy access to the minimum-required parameters during setup.**  
Save valuable time during setup by calling up just the parameters needed.

### Password

**Protect parameter settings.**

Once setup is complete, protect parameter settings with a password from unauthorized personnel.

NEW

### ND/HD Selection

**Dual ratings to fit a wide range of application needs.**

Select between Normal Duty and Heavy Duty for optimized torque performance.

## Functions at Start and Stop

NEW

### Overexcitation Braking

**Perfect for applications with high load inertia that rarely need to be stopped.**

Stop quickly—50% faster without the use of a braking resistor. \*: Stopping times may vary based on motor characteristics.

### DC Injection Braking at Start

**Halt a coasting motor and start it back up again.**

When the direction of a coasting motor is unknown, the drive automatically performs DC Injection to bring the motor to a halt and then start it back up again.

### Speed Search

**Start a coasting motor.**

Automatically brings a coasting motor back to the target frequency without the need for extra speed sensors.

### Accel/Decel Time Switch

**Switch easily between accel/decel times.**

Set different acceleration and deceleration times based on load status and change between those times during operation.

### S-Curve Time

**Prevent sudden shock when starting and stopping the application.**

Drive lets the user fine-tune the S-curve characteristics, allowing for smooth acceleration and deceleration.

### Stopping Method Selection

**Determine the best way to stop the application.**

Program the drive to stop the motor in the way most appropriate for the application.

## Reference Functions

### Run Command Selection

**Select a Run command input method.**

Tell the drive where the Run command is to be given from-- the operator, external terminals, or serial communications.

### Speed Reference Selection

**Select a speed reference input method.**

Tell the drive where the speed reference command is given from-- the operator, external terminals, or serial communications. Determine the type of input for the speed reference, whether a voltage input or current input signal should be used.

### Multi-Function Input

**Select from a wide range of input terminal functions.**

A multitude of input functions available to best suit your application needs.

### Multi-Function Output

**Select the output functions optimal for your application.**

An array of output functions are available to match your application needs.

### Frequency Reference Upper/Lower Limits

**Limit motor speed.**

Set speed limits and eliminate the need for extra peripheral devices and extraneous hardware.

### Multi-Step Speed

**Easily program a speed sequence with multiple steps.**

Set up to 9 separate speeds to create a speed sequence for the application. The drive can easily be connected to a PLC and allow for a simple positioning with limit switches.

### Frequency Jump

**Skip over troublesome resonant frequencies.**

Drive can be programmed to avoid machine resonance problems by avoiding constant speed operation at certain speed.

### Frequency Reference Hold

**Improved operability.**

Momentarily hold the operating frequency during acceleration or deceleration as the load is lowered or raised.

### Up/Down

**Improved operability.**

Raise or lower the frequency reference using a remote switch.

NEW

### LOCAL/REMOTE

**Switch between remote operating locations.**

Easily switch between controlling the drive directly with the keypad or from a control panel at some remote location.

## Functions for Top Performance

### V/f Pattern Characteristics

#### Set a V/f pattern suited for the motor characteristics.

Select the V/f pattern freely to gain optimal motor torque with any load condition.

NEW

### Phase Order Change

#### Easily change the direction of motor rotation.

Change the direction of motor rotation more easily with parameter settings rather than reversing output phase cables to the motor. A time saver when wiring has accidentally been reversed.

### Reverse Prevention

#### Prohibit reverse rotation.

This function keeps the application from rotating in reverse and prevents machine damage, even if a reverse command is accidentally entered.

NEW

### Swing PWM

#### Suppress noise and reduce motor sound.

Creates a more pleasant work environment while suppressing noise and leakage current.

### Torque Compensation

#### Enable automatic adjustment regardless of load fluctuations.

The YASKAWA original full-range fully-automatic torque boost function applies an optimum voltage to the motor regardless of load fluctuations, thus ensuring stable torque output.

### Slip Compensation

#### Suppress speed fluctuation.

Keeps motor speed constant despite changes to the load.

### Electronic Thermal Overload

#### Detect motor overload.

Monitors changes in current to protect the motor. Select the best motor overload protection for the motor type.

### Frequency Detection

#### Use frequency detection for brake control.

The drive can output a signal when the output frequency exceeds a specified level.

### Overtorque Detection

#### Keep the application running while protecting connected machinery.

Overtorque detection senses motor torque and notifies the user immediately when a filter clogs or the machine is blocked by mechanical problems.

## Protective Functions

### Momentary Power Loss Ride-Thru

#### Keep running even during a momentary loss in power.

J1000 automatically restarts the motor and keeps the application going in the event of a power loss.

### Stall Prevention

#### Better reliability: Keep the application running while protecting the load.

Keeps the machine running by preventing motor stall caused by motor overload or rapid speed changes.

### Fault Restart

#### Keep running when a fault occurs.

J1000 has full self-diagnostic features and can restart the application in the event of a fault. Up to 10 restarts possible.

## Maintenance

### NEW Verify Menu

#### Quickly reference all changes to parameter settings.

Review any setting changes in the drive. Particularly helpful during maintenance when performing a test run.

### NEW Accumulated Operation Time

#### Monitor drive operation time.

Keep track of operation time to ensure the drive and application are in top condition.

### NEW Maintenance Monitor

#### Monitor cooling fan and capacitor service life.

Easily check total operation time of various components. Extremely useful for maintenance records and preventative maintenance.

### Fan ON/OFF Control

#### Extend cooling fan operating life.

Maximize cooling fan life by shutting the fan off when the drive is not in operation.



# Parameter List

Refer to J1000 Installation & Start-Up Manual for details.

Function	No.	Name	Range	Default
Initialization Parameters	A1-01	Access Level Selection	0, 2	2
	A1-03	Initialize Parameters	0 to 3330	0
	A1-04	Password 1	0 to 9999	0
	A1-05	Password 2	0 to 9999	0
Operation Mode Selection	b1-01	Frequency Reference Selection	0 to 3	1
	b1-02	Run Command Selection	0 to 2	1
	b1-03	Stopping Method Selection	0, 1	0
	b1-04	Reverse Operation Selection	0, 1	0
	b1-07	LOCAL/REMOTE Run Selection	0, 1	0
	b1-08	Run Command Selection while in Programming Mode	0 to 2	0
	b1-14	Phase Order Selection	0, 1	0
DC Injection Braking	b2-02	DC Injection Braking Current	0 to 75	50%
	b2-03	DC Injection Braking Time/ DC Excitation Time at Start	0.00 to 10.00	0.00 s
	b2-04	DC Injection Braking Time at Stop	0.00 to 10.00	0.50 s
Acceleration and Deceleration Times	C1-01	Acceleration Time 1	0.0 to 6000.0	10.0 s
	C1-02	Deceleration Time 1	0.0 to 6000.0	10.0 s
	C1-03	Acceleration Time 2	0.0 to 6000.0	10.0 s
	C1-04	Deceleration Time 2	0.0 to 6000.0	10.0 s
	C1-09	Fast-Stop Time	0.0 to 6000.0	10.0 s
S-Curve Characteristics	C2-01	S-Curve Characteristic at Accel Start	0.00 to 10.00	0.20 s
	C2-02	S-Curve Characteristic at Accel End	0.00 to 10.00	0.20 s
	C2-03	S-Curve Characteristic at Decel Start	0.00 to 10.00	0.20 s
	C2-04	S-Curve Characteristic at Decel End	0.00 to 10.00	0.00 s
Slip Compensation	C3-01	Slip Compensation Gain	0.0 to 2.5	0.0
	C3-02	Slip Compensation Primary Delay Time	0 to 10000	2000 ms
Torque Compensation	C4-01	Torque Compensation Gain	0.00 to 2.50	1.00
Carrier Frequency	C6-01	Normal/Heavy Duty Selection	0, 1	1
	C6-02	Carrier Frequency Selection	1 to F	*2
	C6-03	Carrier Frequency Upper Limit	1.0 to 15.0	*3
	C6-04	Carrier Frequency Lower Limit	1.0 to 15.0	*3
	C6-05	Carrier Frequency Proportional Gain	00 to 99	*3
Frequency Reference	d1-01	Frequency Reference 1	0.00 to 400.00	0.00 Hz
	d1-02	Frequency Reference 2		0.00 Hz
	d1-03	Frequency Reference 3		0.00 Hz
	d1-04	Frequency Reference 4		0.00 Hz
	d1-05	Frequency Reference 5		0.00 Hz
	d1-06	Frequency Reference 6		0.00 Hz
	d1-07	Frequency Reference 7		0.00 Hz
	d1-08	Frequency Reference 8		0.00 Hz
	d1-17	Jog Frequency Reference		6.00 Hz
Frequency Upper and Lower Limits	d2-01	Frequency Reference Upper Limit	0.0 to 110.0	100.0%
	d2-02	Frequency Reference Lower Limit	0.0 to 110.0	0.0%
Jump Frequency	d3-01	Jump Frequency 1	0.0 to 400.0	0.0 Hz
	d3-02	Jump Frequency 2	0.0 to 400.0	0.0 Hz
	d3-04	Jump Frequency Width	0.0 to 20.0	1.0 Hz
Frequency Reference Hold	d4-01	Frequency Reference Hold Function Selection	0, 1	0
V/f Pattern Characteristics	E1-01	Input Voltage Setting	155 to 255	200 V*1
	E1-03	V/f Pattern Selection	F	F
	E1-04	Max Output Frequency	40.0 to 400.0	60.0 Hz
	E1-05	Max Output Voltage	0.0 to 255.0	200.0 V*1
	E1-06	Base Frequency	0.0 to E1-04	60.0 Hz*1
	E1-07	Mid Output Frequency	0.0 to E1-04	3.0 Hz
	E1-08	Mid Output Frequency Voltage	0.0 to 255.0	16.0 V*1
	E1-09	Minimum Output Freq.	0.0 to 400.0	1.5 Hz
	E1-10	Minimum Output Freq. Voltage	0.0 to 255.0	12.0 V*1

Function	No.	Name	Range	Default
Motor Parameters	E2-01	Motor Rated Current	10 to 200% of drive rated current	*2
	E2-02	Motor Rated Slip	0.00 to 20.00	*2
	E2-03	Motor No-Load Current	0 to less than E2-01	*2
	E2-05	Motor Line-to-Line Resistance	0.000 to 65.000	*2
Multi-Function Digital Inputs	H1-01	Multi-Function Digital Input Terminal S1 Function Selection	1 to 67	40
	H1-02	Multi-Function Digital Input Terminal S2 Function Selection	1 to 67	41
	H1-03	Multi-Function Digital Input Terminal S3 Function Selection	0 to 67	24
	H1-04	Multi-Function Digital Input Terminal S4 Function Selection	0 to 67	14
	H1-05	Multi-Function Digital Input Terminal S5 Function Selection	0 to 67	3 (0) *4
Multi-Function Digital Outputs	H2-01	Terminal MA, MB and MC Function Selection (relay)	0 to 13D	E
Analog Inputs	H3-01	Terminal A1 Signal Level Selection	0 to 3	0
	H3-03	Terminal A1 Gain Setting	-999.9 to 999.9	100.0%
	H3-04	Terminal A1 Bias Setting	-999.9 to 999.9	0.0%
	H3-13	Analog Input Filter Time Constant	0.00 to 2.00	0.03 s
Multi-Function Analog Outputs	H4-01	Multi-Function Analog Output Terminal AM	000 to 999	102
	H4-02	Multi-Function Analog Output Terminal AM Gain	-999.9 to 999.9	100.0%
	H4-03	Multi-Function Analog Output Terminal AM Bias	-999.9 to 999.9	0.0%
MEMOBUS/Modbus Communications	H5-01	Drive Slave Address	0 to FFH	1F
	H5-02	Communication Speed Selection	0 to 5	3
	H5-03	Communication Parity Selection	0 to 2	0
	H5-04	Stopping Method After Communication Error	0 to 3	3
	H5-05	Communication Fault Detection Selection	0, 1	1
	H5-06	Drive Transmit Wait Time	10 to 65	10 ms
	H5-07	RTS Control Selection	0, 1	1
	H5-12	Run Command Method Selection	0, 1	0
Motor Protection Functions	H5-13	MEMOBUS Frequency Reference and Frequency Monitor Unit	0 to 3	0
	L1-01	Motor Overload Protection Selection	0 to 2	1
	L1-02	Motor Overload Protection Time	0.1 to 5.0	1.0 min
Momentary Power Loss	L1-13	Continuous Electrothermal Operation Selection	0, 1	1
	L2-01	Momentary Power Loss Operation Selection	0 to 2	0
Stall Prevention Functions	L3-01	Stall Prevention Selection during Acceleration	0, 1	1
	L3-02	Stall Prevention Level during Acceleration	0 to 150	*5
	L3-04	Stall Prevention Selection during Deceleration	0, 1, 4	1
	L3-05	Stall Prevention Selection during Run	0 to 2	1
	L3-06	Stall Prevention Level during Run	30 to 150	*5
	Frequency Detection	L4-01	Speed Agreement Detection Level	0.0 to 400.0
L4-07		Frequency Detection Conditions	0, 1	0
Fault Reset	L5-01	Number of Auto Restart Attempts	0 to 10	0
Overtorque Detection	L6-01	Torque Detection Selection 1	0 to 4	0
	L6-02	Torque Detection Level 1	0 to 300	150%
	L6-03	Torque Detection Time 1	0.0 to 10.0	0.1 s
Hardware Protection	L8-01	Internal Dynamic Braking Resistor Protection Selection (ERF type)	0, 1	0
	L8-05	Input Phase Loss Protection Selection	0, 1	0
	L8-10	Heatsink Cooling Fan Operation Selection	0, 1	0
	L8-12	Ambient Temperature Setting	-10 to 50	30°C
	L8-18	Soft CLA Selection	0, 1	1
	L8-35	Installation Method Selection	0 to 3	*2
Hunting Prevention	L8-38	Carrier Frequency Reduction	0 to 2	*2
	n1-02	Hunting Prevention Gain Setting	0.00 to 2.50	1.00
High-Slip Braking	n3-13	Overexcitation Deceleration Gain	1.00 to 1.40	1.10
Display Settings	o1-02	User Monitor Selection After Power Up	1 to 4	1
	o1-03	Digital Operator Display Selection	0, 1	0
Operator Keypad Functions	o2-02	STOP Key Function Selection	0, 1	1
	o2-04	Drive Model Selection	0 to FF	*2
	o2-05	Frequency Reference Setting Method Selection	0, 1	0
	o2-06	Operation Selection when Digital Operator is Disconnected	0, 1	0
	o2-09	Initialization Mode	0 to 3	dep. on drive spec.
Copy Functions	o3-01	Copy Function Selection	0 to 3	0
	o3-02	Copy Allowed Selection	0, 1	0
Maintenance Period	o4-01	Accumulated Operation Time Setting	0 to 9999	0 h
	o4-02	Accumulated Operation Time Selection	0, 1	0
	o4-03	Cooling Fan Operation Time Setting	0 to 9999	0 h
	o4-05	Capacitor Maintenance Setting	0 to 150	0%
	o4-07	Soft Charge Bypass Relay Maintenance Setting	0 to 150	0%
	o4-09	IGBT Maintenance Setting	0 to 150	0%
	o4-11	U2 Initialize Selection	0, 1	0

\*1 : Values shown here are for 200 V class drives. Double the value when using a 400 V class drive.

\*2 : Default setting value is dependent on parameter o2-04, Drive Model Selection.

\*3 : Default setting value is dependent on parameter C6-02, Carrier Frequency Selection.

\*4 : Value in brackets indicates default when 3-wire initialization is performed (A1-03 = 3330).

\*5 : Default setting value is dependent on C6-01 and L8-38 settings.

# Basic Instructions

Quick Setup,  
Easy to Operate

## Operator Names and Functions

### Data display (5-digit)

Displays frequency, parameter number, and other data.

### LO/RE light

Lights to indicate that the operator is set for LOCAL.

### LO/RE key

Determines where the Run command and frequency reference come from: the keypad (LOCAL) or the control terminals (REMOTE).

### ESC key

Lets the user back up to the previous display screen.

### Right arrow key

Scrolls the cursor to the right.

### RESET key

Resets a fault.

### Down arrow key

Scrolls down through the display screen, and decreases a selected value.

### LED panel

More information listed below.

### RUN light

Lights when the Run command is present.

### RUN key

Issues a Run command.

### Up arrow key

Scrolls up through the display screen, and increases a selected value.

### STOP key

Issues a Stop command.

### ENTER key

Press to enter values, edit parameters, and set the control mode. Press this key to proceed to the next screen when scrolling through various menu displays.

### Com port

Connect an optional interface for serial communications, remote operator, USB copy unit, or link to a PC using DriveWizard Plus.

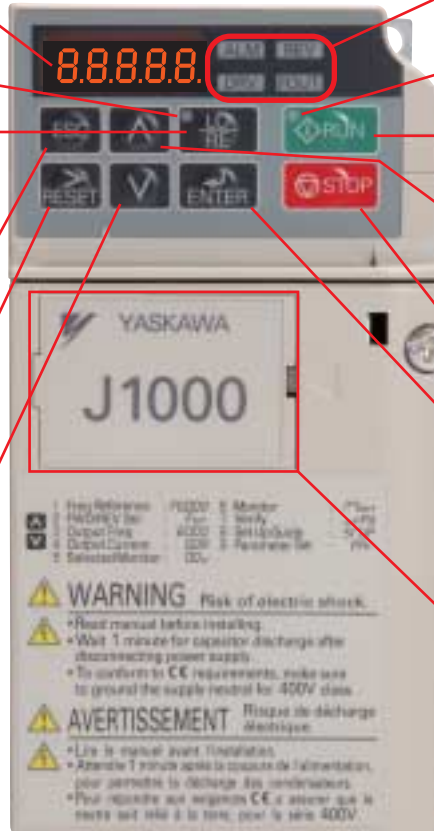

### LED Display Guide

LED	ON	Flashing	OFF
ALM	A fault has occurred.	· Alarm situation detected. · Operator error (OPE)	Normal operation
REV	Motor is rotating in reverse.	—	Motor is rotating forward.
DRV	In the "Drive Mode"	—	Programming Mode
FOUT	Output frequency	—	—
LO/RE	Run command assigned to the operator (LOCAL)	—	Run command assigned to remote location (REMOTE)
RUN	During run	· During deceleration · Run command is present but the frequency reference is zero.	Drive is stopped.

### How the RUN light works:

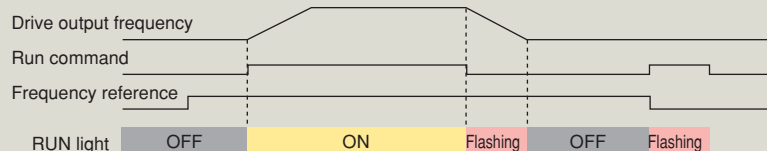

## Operation Example

### Using the LED Operator to Run the Drive

Steps	Key	Result/Display
1 Turn the power on.		F 0.00
2 Set the drive for LOCAL. The frequency reference is displayed.		LO should light. F 0.00
3 Displays the direction (forward).		For
4 Displays the output frequency.		0.00
5 Displays the output current.		0.00A
6 Displays the output voltage.		0.00V
7 Displays the beginning of the Monitor Menu.		flashing r7on
8 Displays the top of the Verify Menu.		flashing urFY
9 Displays the top of the Setup Mode.		flashing srUP
10 Displays the top of the parameter settings menu.		PAR
Returns back to the frequency reference display.		

Value will flash when it is possible to change the setting.

**Drive Mode:** Run and Stop commands, displays operation status such as the frequency reference, output frequency, output current, output voltage, etc.

How to Monitor the Frequency Reference

Steps	Key	Result/Display
Use the arrow keys to select the digits to set.		F 00.00
		F 00.00
Press enter to save the new value.		F 06.00
		F 06.00
		F 06.00 "End" appears while the drive saves the new data. DRV DRV lights up.

**Monitor Mode:** Displays operation status and information on faults.

Steps	Key	Result/Display
Selecting a Monitor for Display Displays U1-01, the frequency reference monitor.		U 1-01
		6.00
Re-select the monitor display menu.		U 1-01
		U 1-02
Back up to the top of the Monitor Menu.		U 1-26
		r7on

**Verify Menu:** Displays parameters changed from the default settings.

Steps	Key	Result/Display
Lists parameters that have been changed in order. Pressing Enter displays the parameter value.		C 1-01
		00030
Parameters that have been changed from their default values are listed in order.		C 1-01
		C 1-02
Returns to the top of the Verify Menu.		C 6-02
		urFY

Press to go back to the previous display screen.

### Setup Mode

The Setup Mode allows you to view and set up the minimum-required parameters to run the drive.

Steps	Key	Result/Display
Parameter check		b 1-01
		C 1-01
Setting change		00 100
		00 100
		00200
		C 1-01

Scroll using the up arrow key and see which parameters have been selected.

Setup Mode Parameters

No.	Name	No.	Name
b1-01	Frequency Reference Selection 1	d1-17	Jog Frequency Reference
b1-02	Run Command Selection 1	E1-01	Input Voltage Setting
b1-03	Stopping Method Selection	E1-04	Max Output Frequency
C1-01	Acceleration Time 1	E1-05	Max Output Voltage
C1-02	Deceleration Time 1	E1-06	Base Frequency
C6-01	Normal/Heavy Duty Selection	E1-09	Minimum Output Freq.
C6-02	Carrier Frequency Selection	E2-01	Motor Rated Current
d1-01	Frequency Reference 1	H4-02	Multi-Function Analog Output Terminal AM Gain
d1-02	Frequency Reference 2	L1-01	Motor Overload Protection Selection
d1-03	Frequency Reference 3	L3-04	Stall Prevention Selection during Deceleration
d1-04	Frequency Reference 4	-	-

# Product Lineup

Number in parenthesis indicates the rated output current.

Motor Capacity kW	Single-Phase 100 V		Three-Phase 200 V		Single-Phase 200 V		Three-Phase 400 V	
	Normal Duty	Heavy Duty	Normal Duty	Heavy Duty	Normal Duty	Heavy Duty	Normal Duty	Heavy Duty
0.1		CIMR-JAAA0001		CIMR-JA2A0001 (0.8 A)		CIMR-JABA0001 (0.8 A)		
0.2	CIMR-JAAA0001	CIMR-JAAA0002	CIMR-JA2A0001 (1.2 A)	CIMR-JA2A0002 (1.6 A)	CIMR-JABA0001 (1.2 A)	CIMR-JABA0002 (1.6 A)		CIMR-JA4A0001 (1.2 A)
0.4	CIMR-JAAA0002	CIMR-JAAA0003	CIMR-JA2A0002 (1.9 A)	CIMR-JA2A0004 (3 A)	CIMR-JABA0002 (1.9 A)	CIMR-JABA0003 (3 A)	CIMR-JA4A0001 (1.2 A)	CIMR-JA4A0002 (1.8 A)
0.75	CIMR-JAAA0003	CIMR-JAAA0006	CIMR-JA2A0004 (3.5 A)	CIMR-JA2A0006 (5 A)	CIMR-JABA0003 (3.3 A)	CIMR-JABA0006 (5 A)	CIMR-JA4A0002 (2.1 A)	CIMR-JA4A0004 (3.4 A)
1.1	CIMR-JAAA0006		CIMR-JA2A0006 (6 A)	CIMR-JA2A0008 (6.9 A)	CIMR-JABA0006 (6 A)			
1.5			CIMR-JA2A0008 (8 A)	CIMR-JA2A0010 (8 A)		CIMR-JABA0010 (8 A)	CIMR-JA4A0004 (4.1 A)	CIMR-JA4A0005 (4.8 A)
2.2			CIMR-JA2A0010 (9.6 A)	CIMR-JA2A0012 (11 A)	CIMR-JABA0010 (9.6 A)		CIMR-JA4A0005 (5.4 A)	CIMR-JA4A0007 (5.5 A)
3.0			CIMR-JA2A0012 (12 A)	CIMR-JA2A0018 (14 A)			CIMR-JA4A0007 (6.9 A)	CIMR-JA4A0009 (7.2 A)
3.7			CIMR-JA2A0018 (17.5 A)	CIMR-JA2A0020 (17.5 A)			CIMR-JA4A0009 (8.8 A)	CIMR-JA4A0011 (9.2 A)
5.5			CIMR-JA2A0020 (19.6 A)				CIMR-JA4A0011 (11.1 A)	

⊞: Under development

## Model Number Key

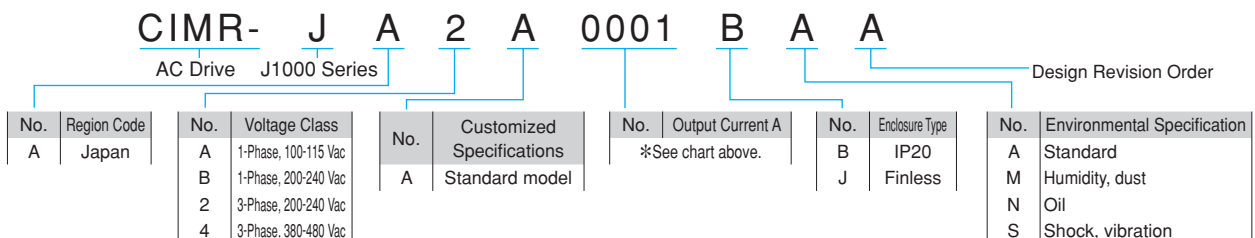



## Optimizing Control for Each Application

J1000 offers two separate performance ratings: Normal Duty and Heavy Duty.

Heavy Duty is capable of creating more powerful torque, while Normal Duty allows the drive to operate a larger motor.

Difference between load ratings:

	Normal Duty Rating	Heavy Duty Rating
Parameter settings	C6-01 = 1 (default)	C6-01 = 0
Overload tolerance	120% for 60 s	150% for 60 s
Carrier frequency	Low carrier frequency*	High carrier frequency

\*: Use Swing PWM to quiet undesirable motor noise generated when operating with a low carrier frequency.

### Normal Duty Applications



### Heavy Duty Applications



\*The applications shown above can still use the ND rating, provided that the maximum torque required is no more than 120% for 60 s.

#### ● Selecting a Drive

For a fan application using a 0.75 kW motor, select CIMR-JA2A0004 and set it for Normal Duty performance.

Model: CIMR-JA2A0004

Normal Duty: 0.75 kW      0.75 kW      Fan

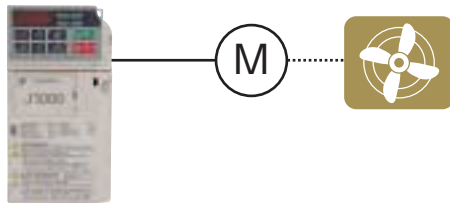

#### ● Selecting a Drive

For a conveyor application using a 0.75 kW motor, select CIMR-JA2A0006 and set it for Heavy Duty performance.

Model: CIMR-JA2A0006

Heavy Duty: 0.75 kW      0.75 kW      Conveyor

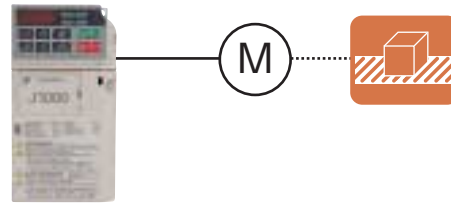

Use the table below to transition from VS mini C or VS mini J7 to the J1000 series.

Max. Applicable Motor Capacity (kW)	100 V		200 V				400 V	
	Single-Phase		Three-Phase		Single-Phase		Three-Phase	
	VS mini C	J1000	VS mini J7	J1000	VS mini J7	J1000	VS mini J7	J1000
	CIMR-XCAAA[...]	CIMR-JAAA[...]	CIMR-J7AA2[...]	CIMR-JA2A[...]	CIMR-J7AAB[...]	CIMR-JABA[...]	CIMR-J7AA4[...]	CIMR-JA4A[...]
0.1	0P1	0001	0P1	0001	0P1	0001	—	—
0.2	0P2	0002	0P2	0002	0P2	0002	0P2	0001
0.4	0P4	0004	0P4	0004	0P4	0003	0P4	0002
0.75	0P7	0006	0P7	0006	0P7	0006	0P7	0004
1.5	—	—	1P5	0010	1P5	0010	1P5	0005
2.2	—	—	2P2	0012	—	—	2P2	0007
3.7	—	—	3P7	0020	—	—	3P7	0011

# J Standard Specifications

Parameter C6-01 sets the drive for Normal Duty or Heavy Duty performance.

## 200 V Class (Three-Phase/Single-Phase)

Value in brackets is for a single-phase drive.

Model	Three-Phase	CIMR-JA2A	0001	0002	0004	0006	0008	0010	0012	0018	0020		
	Single-Phase*1	CIMR-JABA	0001	0002	0003	0006	–	0010	–	–	–		
Max. Applicable Motor Capacity*2	kW	Normal Duty	0.2	0.4	0.75	1.1	1.5	2.2	3.0	3.7	5.5		
		Heavy Duty	0.1	0.2	0.4	0.75	1.1	1.5	2.2	3.0	3.7		
Input	Rated Input Current*3	Three-phase	Normal Duty	1.1	1.9	3.9	7.3	8.8	10.8	13.9	18.5	24.0	
			Heavy Duty	0.7	1.5	2.9	5.8	7.0	7.5	11.0	15.6	18.9	
		A	Single-phase	Normal Duty	2.0	3.6	7.3	13.8	–	20.2	–	–	–
			Heavy Duty	1.4	2.8	5.5	11.0	–	14.1	–	–	–	
Output	Rated Output Capacity*4	kVA	Normal Duty	0.5	0.7	1.3	2.3	3.0	3.7	4.6	6.7	7.5	
			Heavy Duty	0.3	0.6	1.1	1.9	2.6	3.0	4.2	5.3	6.7	
	Rated Output Current	A	Normal Duty*5	1.2	1.9	3.5(3.3)	6.0	8.0	9.6	12.0	17.5	19.6	
			Heavy Duty	0.8*6	1.6*6	3.0*6	5.0*6	6.9*7	8.0*7	11.0*7	14.0*7	17.5*7	
	Overload Tolerance		Normal Duty Rating: 120% of rated output current for 60 s. Heavy Duty Rating: 150% of rated output current for 60 s. (Derating may be required for repetitive loads)										
	Carrier Frequency		2 kHz (user-set, up to 15 kHz possible)										
	Max. Output Voltage		Three-phase power supply: three-phase 200 to 240 V (relative to input voltage) Single-phase power supply: three-phase 200 to 240 V (relative to input voltage)										
	Max. Output Frequency		400 Hz (user-set)										
	Rated Voltage/Rated Frequency		Three-phase power supply: three-phase 200 to 240 V 50/60 Hz Single-phase power supply: single-phase 200 to 240 V 50/60 Hz										
	Allowable Voltage Fluctuation		–15 to +10%										
Allowable Frequency Fluctuation		±5%											
Power	Power Supply	Three-phase	Normal Duty	0.5	0.9	1.8	3.3	4.0	4.9	6.4	8.5	11.0	
			Heavy Duty	0.3	0.7	1.3	2.7	3.2	3.4	5.0	7.1	8.6	
		kVA	Single-phase	Normal Duty	0.5	1.0	1.9	3.6	–	5.3	–	–	–
			Heavy Duty	0.4	0.7	1.5	2.9	–	3.7	–	–	–	

\*1: Drives with a single-phase power supply input have three-phase output. Single-phase motors cannot be used.

\*2: The motor capacity (kW) refers to a Yaskawa 4-pole, 60 Hz, 200 V motor. The rated output current of the drive output amps should be equal to or greater than the motor rated current.

\*3: Assume operation at rated output current. This value may fluctuate based on the power supply side impedance, as well as the input current, power supply transformer, input side reactor, and wiring conditions.

\*4: Rated output capacity is calculated with a rated output voltage of 220 V.

\*5: This value assumes a carrier frequency of 2 kHz. Increasing the carrier frequency requires a reduction in current.

\*6: This value assumes a carrier frequency of 10 kHz. Increasing the carrier frequency requires a reduction in current.

\*7: This value assumes a carrier frequency of 8 kHz. Increasing the carrier frequency requires a reduction in current.

## 400 V Class (Three-phase)

Model	CIMR-JA4A	0001	0002	0004	0005	0007	0009	0011			
Max. Applicable Motor Capacity*1	kW	Normal Duty	0.4	0.75	1.5	2.2	3.0	3.7	5.5		
		Heavy Duty	0.2	0.4	0.75	1.5	2.2	3.0	3.7		
Input	Rated Input Current*2	A	Normal Duty	1.2	2.1	4.3	5.9	8.1	9.4	14.0	
			Heavy Duty	1.2	1.8	3.2	4.4	6.0	8.2	10.4	
Output	Rated Output Capacity*3	kVA	Normal Duty*4	0.9	1.6	3.1	4.1	5.3	6.7	8.5	
			Heavy Duty*5	0.9	1.4	2.6	3.7	4.2	5.5	7.0	
	Rated Output Current	A	Normal Duty*4	1.2	2.1	4.1	5.4	6.9	8.8	11.1	
			Heavy Duty*5	1.2	1.8	3.4	4.8	5.5	7.2	9.2	
Overload Tolerance		Normal Duty Rating: 120% of rated output current for 60 s. Heavy Duty Rating: 150% of rated output current for 60 s. (Derating may be required for repetitive loads)									
Carrier Frequency		2 kHz (user-set, up to 15 kHz possible)									
Max. Output Voltage		Three-phase 380 to 480 V (relative to input voltage)									
Max. Output Frequency		400 Hz (user-set)									
Rated Voltage/Rated Frequency		Three-phase 380 to 480 V 50/60 Hz									
Allowable Voltage Fluctuation		–15 to +10%									
Allowable Frequency Fluctuation		±5%									
Power	Power Supply	kVA	Normal Duty	1.1	1.9	3.9	5.4	7.4	8.6	13.0	
			Heavy Duty	1.1	1.6	2.9	4.0	5.5	7.5	9.5	

\*1: The motor capacity (kW) refers to a Yaskawa 4-pole, 60 Hz, 400 V motor. The rated output current of the drive output amps should be equal to or greater than the motor rated current.

\*2: Assume operation at rated output current. This value may fluctuate based on the power supply side impedance, as well as the input current, power supply transformer, input side reactor, and wiring conditions.

\*3: Value displayed is for when operating at the rated output current. Rated output capacity is calculated with a rated output voltage of 440 V.

\*4: This value assumes a carrier frequency of 2 kHz. Increasing the carrier frequency requires a reduction in current.

\*5: This value assumes a carrier frequency of 8 kHz. Increasing the carrier frequency requires a reduction in current.

## Common Specifications

	Item	Specifications
Control Characteristics	Control Method	V/f Control
	Frequency Control Range	0.01 to 400 Hz
	Frequency Accuracy (Temperature Fluctuation)	Digital input: within $\pm 0.01\%$ of the max. output frequency ( $-10$ to $+50^{\circ}\text{C}$ ) Analog input: within $\pm 0.1\%$ of the max. output frequency ( $25^{\circ}\text{C} \pm 10^{\circ}\text{C}$ )
	Frequency Setting Resolution	Digital input: 0.01 Hz Analog input: 1/1000 of max. frequency
	Output Frequency Resolution	20 bit resolution at maximum output frequency
	Frequency Setting Resolution	Main frequency reference : 0 to +10 Vdc (20 k $\Omega$ ), 4 to 20 mA (250 $\Omega$ ), 0 to 20 mA (250 $\Omega$ )
	Starting Torque	150% / 3 Hz
	Speed Control Range	1:20 to 1:40
	Accel/Decel Time	0.0 to 6000.0 s (4 selectable combinations of independent acceleration and deceleration settings)
	Braking Torque	① Short-time decel torque* <sup>1</sup> : over 150% for 0.1/0.2 kW motors, over 100% for 0.4/ 0.75 kW motors, over 50% for 1.5 kW motors, and over 20% for 2.2 kW and above motors. ② Continuous regen. torque: approx. 20% (approx. 125% with dynamic braking resistor option* <sup>2</sup> : 10% ED, 10 s, internal braking transistor)
	V/f Characteristics	User-selected programs, V/f preset patterns possible
Main Control Functions	Momentary power loss ride-thru, Speed search, 9-step speed (max), Accel/decel time switch, S-curve accel/decel, 3-wire sequence, Cooling fan on/off switch, Slip compensation, Torque compensation, Frequency jump, Upper/lower limits for frequency reference, DC injection braking at start and stop, Overexcitation braking, Fault restart ...	
Protection Function	Motor Protection	Motor overheat protection based on output current
	Momentary Overcurrent Protection	Drive stops when output current exceeds 200% of Heavy Duty Rating
	Overload Protection	Drive stops after 60 s at 150% of rated output current (Heavy Duty Rating)* <sup>3</sup>
	Overvoltage Protection	200 V class: Stops when DC bus exceeds approx. 410 V 400 V class: Stops when DC bus exceeds approx. 820 V
	Undervoltage Protection	Stops when DC bus voltage falls below the following levels: Three-phase 200 V class: approx. 190 V, single-phase 200 V class: approx. 160 V, three-phase 400 V class: approx. 380 V, three-phase 380 V class: approx. 350 V
	Momentary Power Loss Ride-Thru	Stops after approx. 15 ms (default).
	Heatsink Overheat Protection	Protection by thermistor
	Braking Resistance Overheat Protection	Overheat sensor for braking resistor (optional ERF-type, 3% ED)
	Stall Prevention	Separate settings allowed during acceleration and during run. Enable/disable only during deceleration.
	Ground Fault Protection	Protection by electronic circuit * <sup>4</sup>
Operating Environment	Charge LED	Charge LED remains lit until DC bus has fallen below approx. 50 V
	Area of Use	Indoors
	Ambient Temperature	$-10$ to $+50^{\circ}\text{C}$ (open chassis), $-10$ to $+40^{\circ}\text{C}$ (NEMA Type 1)
	Humidity	95 RH% or less (no condensation)
	Storage Temperature	$-20$ to $+60^{\circ}\text{C}$ (short-term temperature during transportation)
	Altitude	Up to 1000 meters
Safety Standard	Shock	10 to less than 20 Hz (9.8 m/s <sup>2</sup> ) max., 20 to 55 Hz (5.9 m/s <sup>2</sup> ) max.
	Safety Standard	UL508C
Protection Design	IP20 open-chassis, NEMA 1 enclosure (option)	

\*1: Momentary average deceleration torque refers to the deceleration torque from 60Hz down to 0 Hz. This may vary depending on the motor.

\*2: Parameter L3-04 should be disabled when a Braking Resistor or Braking Resistor Unit is connected.

\*3: Overload protection may be triggered at lower levels if output frequency is below 6 Hz.

\*4: Protection may not be provided under the following conditions as the motor windings are grounded internally during run:

- Low resistance to ground from the motor cable or terminal block.
- Drive already has a short-circuit when the power is turned on.



## Terminal Functions

### Main Circuit Terminals

Terminal	Terminal Name	Function (Signal Level)
R/L1	Main circuit power supply input	Connects line power to the drive. Drives with single phase 100 V input or single phase 200 V input power use terminals R/L1 and S/L2 only (do not use T/L3).
S/L2		
T/L3		
U/T1	Drive output	Connects to the motor.
V/T2		
W/T3		
B1	Braking resistor	Available for connecting a braking resistor.
B2		
+1	DC reactor connection	These terminals are shorted for shipment. Remove the jumper creating the short to install a DC choke.
+2		
+1	DC power supply input	For connecting a DC power supply. Note: DC power supply input terminals (+1, -) are not UL/cUL and CE certified.
-		
⊕ Two terminals	Ground	Grounding terminal Grounding resistance for 100 V and 200 V class: 100 Ω or less Grounding resistance for 400 V class: 10 Ω or less

### Control Circuit Input Terminals

Terminal	No.	Terminal Name (Function)	Function (Signal Level)	Default Setting
Multi-function digital input	S1	Multi-function input 1	Closed: Forward run (default) Open: Stop	Photocoupler 24 Vdc, 8 mA  Note: Drive preset to sinking mode. When using source mode, set DIP switch S3 to allow for a 24 Vdc (±10%) external power supply.
	S2	Multi-function input 2	Closed: Reverse run (default) Open: Stop	
	S3	Multi-function input 3	External fault, N.O. (default)	
	S4	Multi-function input 4	Fault reset (default)	
	S5	Multi-function input 5	Multi-step speed reference 1 (default)	
	SC	Multi-function input common (Control common)	Sequence common	
Main frequency reference input	+V	Analog input power supply	+10.5 V (max. allowable current 20 mA)	
	A1	Main frequency reference	Input voltage or input current 0 to +10 Vdc (20 kΩ) resolution: 1/1000 4 to 20 mA or 0 to 20 mA (250 Ω) resolution: 1/500	
	AC	Frequency reference common	0 V	
Multi-function digital output*	MA	N.O. output	Fault (default)	Digital output 30 Vdc, 10 mA to 1 A 250 Vac, 10 mA to 1 A
	MB	N.C. output	Fault (default)	
	MC	Digital output common		
Monitor output	AM	Analog monitor output	0 to 10 Vdc (2 mA or less) Resolution: 1/256	
	AC	Monitor common	0 V	

\*: Refrain from assigning functions to terminals MA and MB that involve frequent switching, as doing so may shorten relay performance life. Switching life is estimated at 200,000 times (assumes 1 A, resistive load).

# J Dimensions

## Enclosures

Standard J1000 uses an open-chassis design (IP20).

NEMA 1 kits are available to convert the standard IP20 design to a NEMA Type 1 enclosure rating.

### Open-Chassis [ IP20 ]

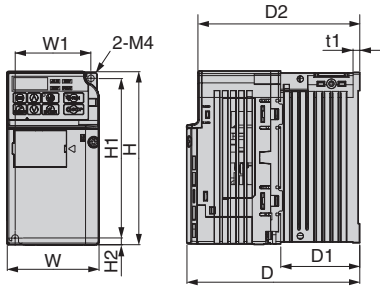

Figure 1

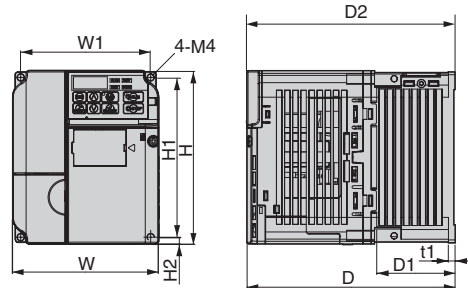

Figure 2

Voltage Class	Model CIMR-JA:.....	Figure	Dimensions (mm)									Weight (kg)	Cooling
			W	H	D	W1	H1	H2	D1	D2	t1		
200 V Class (Three-Phase)	2A0001B	1	68	128	76	56	118	5	6.5	67.5	3	0.6	Self-cooled
	2A0002B		68	128	76	56	118	5	6.5	67.5	3	0.6	
	2A0004B		68	128	108	56	118	5	38.5	99.5	5	0.9	
	2A0006B		68	128	128	56	118	5	58.5	119.5	5	1.1	
	2A0008B	2	108	128	129	96	118	5	58	120.5	5	1.7	Fan cooled
	2A0010B		108	128	129	96	118	5	58	120.5	5	1.7	
	2A0012B		108	128	137.5	96	118	5	58	129	5	1.7	
	2A0018B		140	128	143	128	118	5	65	134.5	5	2.4	
2A0020B	140	128	143	128	118	5	65	134.5	5	2.4			
200 V Class (Single-Phase)	BA0001B	1	68	128	76	56	118	5	6.5	67.5	3	0.6	Self-cooled
	BA0002B		68	128	76	56	118	5	6.5	67.5	3	0.6	
	BA0003B		68	128	118	56	118	5	38.5	109.5	5	1.0	
	BA0006B	2	108	128	137.5	96	118	5	58	129	5	1.7	Fan cooled
	BA0010B		108	128	154	96	118	5	58	145.5	5	1.8	
400 V Class (Three-Phase)	4A0001B	2	108	128	81	96	118	5	10	72.5	5	1.0	Self-cooled
	4A0002B		108	128	99	96	118	5	28	90.5	5	1.2	
	4A0004B		108	128	137.5	96	118	5	58	129	5	1.7	
	4A0005B		108	128	154	96	118	5	58	145.5	5	1.7	Fan cooled
	4A0007B		108	128	154	96	118	5	58	145.5	5	1.7	
	4A0009B		108	128	154	96	118	5	58	145.5	5	1.7	
	4A0011B		140	128	143	128	118	5	65	134.5	5	2.4	

■ Enclosure Panel [NEMA Type1]

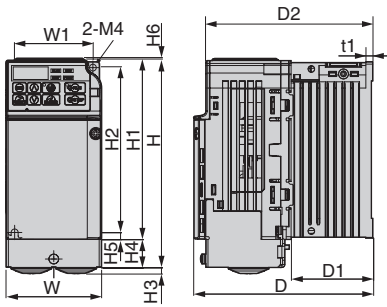

Figure 1

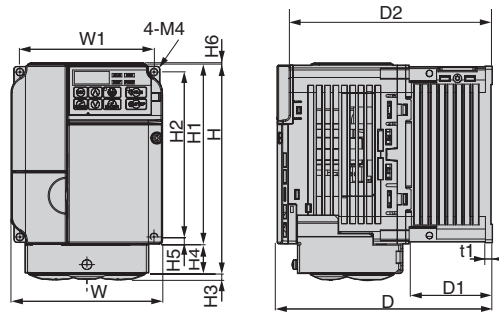

Figure 2

Voltage Class	Model CIMR-JA:□□□□	Figure	Dimensions (mm)													Weight (kg)	Cooling	NEMA 1 Kit Code No.
			W	H	D	W1	H1	H2	H3	H4	H5	H6	D1	D2	t1			
200 V Class (Three-Phase)	2A0001B	1	68	148	76	56	128	118	4.4	20	5	1.5	6.5	67.5	3	0.8	Self-cooled	100-036-378
	2A0002B		68	148	76	56	128	118	4.4	20	5	1.5	6.5	67.5	3	0.8		
	2A0004B		68	148	108	56	128	118	4.4	20	5	1.5	38.5	99.5	5	1.1		
	2A0006B		68	148	128	56	128	118	4.4	20	5	1.5	58.5	119.5	5	1.3		
	2A0008B	2	108	148.9	129	96	128	118	4.4	20.9	5	1.5	58	120.5	5	1.9	Fan cooled	100-036-380
	2A0010B		108	148.9	129	96	128	118	4.4	20.9	5	1.5	58	120.5	5	1.9		
	2A0012B		108	148.9	137.5	96	128	118	4.4	20.9	5	1.5	58	129	5	1.9		
	2A0018B		140	148.9	143	128	128	118	4.5	20.9	5	5	65	134.5	5	2.6		
2A0020B	140	148.9	143	128	128	118	4.5	20.9	5	5	65	134.5	5	2.6				
200 V Class (Single-Phase)	BA0001B	1	68	148	76	56	128	118	4.4	20	5	1.5	6.5	67.5	3	0.8	Self-cooled	100-036-378
	BA0002B		68	148	76	56	128	118	4.4	20	5	1.5	6.5	67.5	3	0.8		
	BA0003B		68	148	118	56	128	118	4.4	20	5	1.5	38.5	109.5	5	1.2		
	BA0006B	2	108	148.9	137.5	96	128	118	4.4	20.9	5	1.5	58	129	5	1.9	Fan cooled	100-036-381
	BA0010B		108	148.9	154	96	128	118	4.5	20.9	5	1.5	58	145.5	5	2		
400 V Class (Three-Phase)	4A0001B	2	108	148.9	81	96	128	118	4.4	20.9	5	1.5	10	72.5	5	1.2	Self-cooled	100-036-380
	4A0002B		108	148.9	99	96	128	118	4.4	20.9	5	1.5	28	90.5	5	1.4		
	4A0004B		108	148.9	137.5	96	128	118	4.4	20.9	5	1.5	58	129	5	1.9		
	4A0005B		108	148.9	154	96	128	118	4.5	20.9	5	1.5	58	145.5	5	1.9		
	4A0007B		108	148.9	154	96	128	118	4.5	20.9	5	1.5	58	145.5	5	1.9	Fan cooled	100-036-383
	4A0009B		108	148.9	154	96	128	118	4.5	20.9	5	1.5	58	145.5	5	1.9		
	4A0011B		140	148.9	143	128	128	118	4.5	20.9	5	5	65	134.5	5	2.6		

Note: The table above lists dimensions of standard drives using the NEMA 1 kit.

# J Drive Watts Loss Data

## Normal Duty Ratings

Model	Model Number		0001	0002	0004	0006	0008	0010	0012	0018	0020	
200 V Class (Three-Phase)	CIMR-JA2A[ ]											
	Motor Capacity	kW	0.2	0.4	0.75	1.1	1.5	2.2	3	3.7	5.5	
	Rated Output Current	A	1.2	1.9	3.5	6	8	9.6	12	17.5	19.6	
	Heat Loss	Heatsink	W	5.0	7.6	15.8	27.5	44.6	51.7	61.3	89.8	98.7
		Internal	W	8.0	9.5	13.6	17.2	24.0	25.8	30.4	44.1	46.3
Total Heat Loss		W	13.0	17.1	29.4	44.7	68.6	77.5	91.7	133.9	145.0	

Model	Model Number		0001	0002	0003	0006	0010	
200 V Class (Single-Phase)	CIMR-JABA[ ]							
	Motor Capacity	kW	0.2	0.4	0.75	1.1	2.2	
	Rated Output Current	A	1.2	1.9	3.3	6	9.6	
	Heat Loss	Heatsink	W	5.0	7.6	14.6	30.1	51.7
		Internal	W	8.5	9.7	14.4	19.4	29.8
Total Heat Loss		W	13.5	17.3	29.0	49.5	81.5	

Model	Model Number		0001	0002	0004	0005	0007	0009	0011	
400 V Class (Three-Phase)	CIMR-JA4A[ ]									
	Motor Capacity	kW	0.4	0.75	1.5	2.2	3.0	3.7	5.5	
	Rated Output Current	A	1.2	2.1	4.1	5.4	6.9	8.8	11.1	
	Heat Loss	Heatsink	W	10.0	18.5	30.5	44.5	58.5	63.7	81.7
		Internal	W	9.6	13.9	16.8	21.8	28.5	31.4	46.0
Total Heat Loss		W	19.6	32.4	47.3	66.3	87.0	95.1	127.7	

Note: Heat loss data based on carrier frequency of 2 kHz (default).

## Heavy Duty Ratings

Model	Model Number		0001*1	0002*1	0004*1	0006*1	0008*1	0010*2	0012*2	0018*2	0020*2	
200 V Class (Three-Phase)	CIMR-JA2A[ ]											
	Motor Capacity	kW	0.1	0.2	0.4	0.75	1.1	1.5	2.2	3	3.7	
	Rated Output Current	A	0.8	1.6	3	5	6.9	8	11	14	17.5	
	Heat Loss	Heatsink	W	4.3	7.9	16.1	27.4	48.7	54.8	70.7	92.6	110.5
		Internal	W	7.3	8.8	11.5	15.9	22.2	23.8	30.0	38.8	43.3
Total Heat Loss		W	11.6	16.7	27.6	43.3	70.9	78.6	100.7	131.4	153.8	

Model	Model Number		0001*1	0002*1	0003*1	0006*1	0010*2	
200 V Class (Single-Phase)	CIMR-JABA[ ]							
	Motor Capacity	kW	0.1	0.2	0.4	0.75	1.5	
	Rated Output Current	A	0.8	1.6	3	5	8	
	Heat Loss	Heatsink	W	4.3	7.9	16.1	33.7	54.8
		Internal	W	7.4	8.9	11.5	16.8	25.9
Total Heat Loss		W	11.7	16.8	27.6	50.5	80.7	

Model	Model Number		0001*2	0002*2	0004*2	0005*2	0007*2	0009*2	0011*2	
400 V Class (Three-Phase)	CIMR-JA4A[ ]									
	Motor Capacity	kW	0.2	0.4	0.75	1.5	2.2	3.0	3.7	
	Rated Output Current	A	1.2	1.8	3.4	4.8	5.5	7.2	9.2	
	Heat Loss	Heatsink	W	19.2	28.9	42.3	70.7	81	84.6	107.2
		Internal	W	11.4	14.9	17.9	26.2	30.7	32.9	41.5
Total Heat Loss		W	30.6	43.8	60.2	96.9	111.7	117.5	148.7	

\*1: Heat loss data based on a carrier frequency of 10 kHz (default).

\*2: Heat loss data based on a carrier frequency of 8 kHz (default).



## ● Attachment for External Heatsink

Additional attachments required for installation.  
Final dimensions are taller than drive height.

Dimensions (Heatsink for a 200 V 0.4 kW drive)

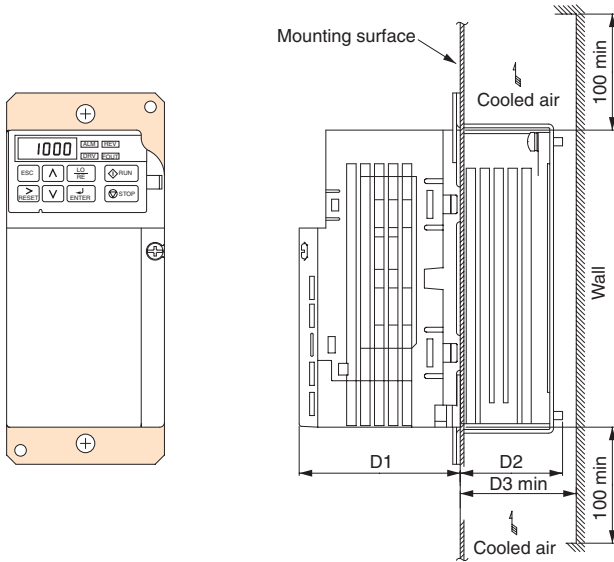

Model CIMR-JA:.....	Dimensions (mm)			Code No.	
	D1	D2	D3		
2A0001	69.2	12	30	100-034-075	
2A0002		42	50		
2A0004		62	70		
2A0006	71	58	70	100-034-079	
2A0008					
2A0010					
2A0012	79.5	65	70	100-034-080	
2A0018					
2A0020					
BA0001	69.2	12	30	100-034-075	
BA0002		42	50		
BA0003		79.2	42		50
BA0006	79.5	58	70	100-036-418	
BA0010		96	58		70
4A0001		71	13.2		30
4A0002	71	28	40		
4A0004	79.5	58	70		
4A0005	96	58	70	100-034-079	
4A0007					
4A0009					
4A0011	78	65	70	100-034-080	

DIN rail attachment available for quick mounting and disassembly.

## ● DIN Rail Attachment

Dimensions (Heatsink for a 200 V 0.4 kW drive)

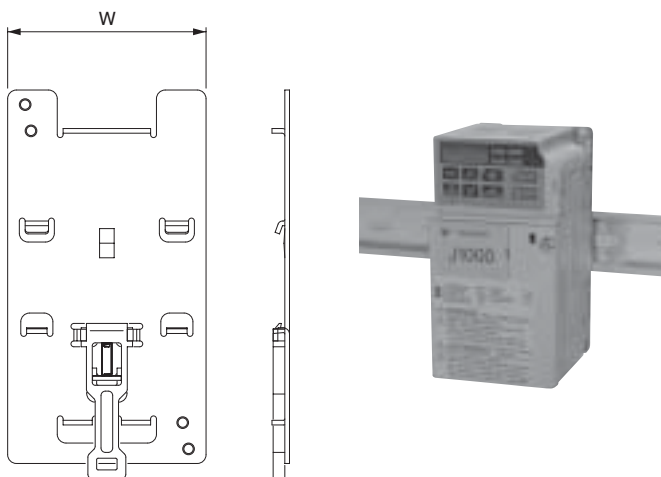

Model CIMR-JA:.....	Width (mm)	Code No.
2A0001	68	EZZ08122A
2A0002		
2A0004		
2A0006	108	EZZ08122B
2A0008		
2A0010		
2A0012	140	EZZ08122C
2A0018		
2A0020		
BA0001	68	EZZ08122A
BA0002		
BA0003		
BA0006	108	EZZ08122B
BA0010		
4A0001		
4A0002		
4A0004		
4A0005	140	EZZ08122C
4A0007		
4A0009		
4A0011	140	EZZ08122C

# J Peripheral Devices and Options

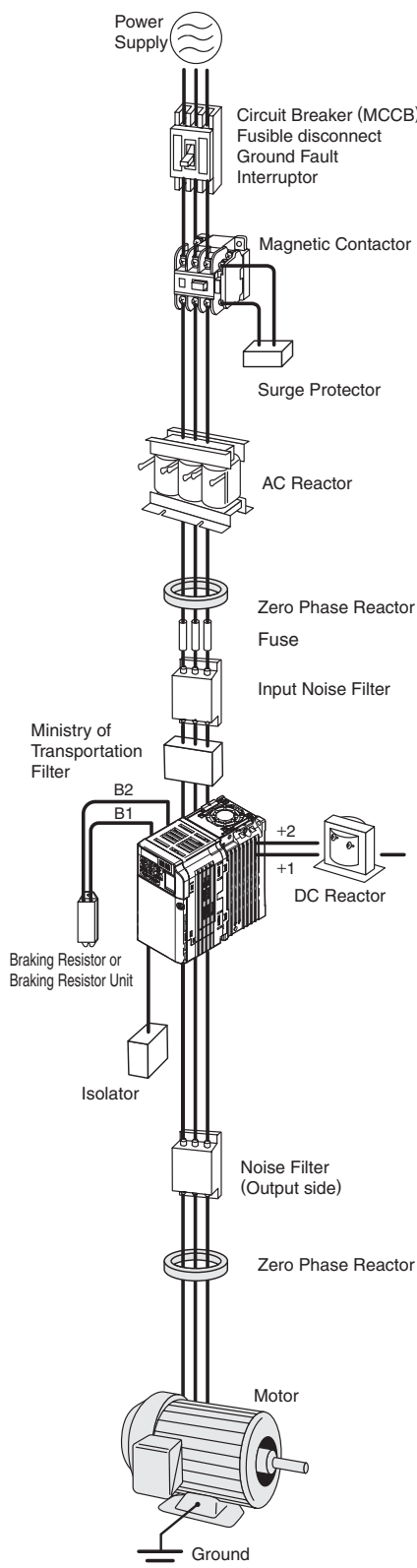

Name	Purpose	Model, Manufacturer	Page
Circuit Breaker	Protects circuitry from excessive current.	Recommended: NF series by Mitsubishi Electric	p. 27
Ground Fault Interruptor (GFI)	Choose a GFI designed for use with a frequency meter.	Recommended: NV series by Mitsubishi Electric EG, SG series by Fuji Electric	—
Magnetic Contactor	Interrupts the power supply to the drive.	Recommended: SC series by Fuji Electric	p. 27
Surge Protector	Absorbs the voltage surge from switching of electro-magnetic contactors and control relays.	DCR2 series RFN series by Nippon Chemi-Con Corporation	p. 28
DC Reactor	Used for harmonic current suppression and total improving the power factor. Should be used if the power supply capacity is larger than 600 kVA.	UZDA series	p. 29
AC Reactor		UZBA series	p. 30
Zero Phase Reactor	Reduces noise from the line that enters into the drive input power system. Should be installed as close as possible to the drive. Can be used on both the input and output sides.	F6045GB F11080GB by Hitachi Metals, Ltd.	p. 31
Fuse / Fuse Holder	Protects internal circuitry in the event of component failure. Fuse should be connected to the input terminal of the drive.	CR6L series /CMS series by Fuji Electric	p.32
Capacitor-type Noise Filter	Reduces noise from the line that enters into the drive input power system. The noise filter can be used in combination with a zero-phase reactor. Note: Available for drive input only. Do not connect the noise filter to the output terminals.	3XYG 1003 by Okaya Electric Industries	p. 32
Input Noise Filter	Reduces noise from the line that enters into the drive input power system. Should be installed as close as possible to the drive.	LNFD series LNFB series For CE Marking (EMC Directive) compliant models, refer to J1000 Installation & Start-Up Manual.	p. 33, 34
Output Noise Filter	Reduces noise from the line that enters into the drive input power system. Should be installed as close as possible to the drive.	LF series by NEC TOKIN Corporation	p. 35
Isolator	Isolates the drive I/O signal, and is effective in reducing inductive noise.	DGP2 series	p. 36
Braking Resistor	Used to shorten the deceleration time by dissipating regenerative energy through a resistor. (3% ED)	ERF-150WJ series	p. 37, 38
Braking Resistor Unit	Used to shorten the deceleration time by dissipating regenerative energy through a resistor. A thermal overload relay is built in. (10% ED)	LKEB series	p. 37, 38
Potentiometer Option Unit	Sets the frequency reference.	AI-V3/J Available soon	—
RS-232C Interface for remote operator	Interface required for use with the optional LED operator.	SI-232/J	p. 39
RS-232C Interface for copy unit/PC communication	Interface required for use with DriveWizard Plus, the optional LED operator, and USB Copy Unit.	SI-232/JC	p. 39
USB Copy Unit (RJ-45/USB compatible plug)	Used to copy parameter settings, or serves as a DriveWizard cable to connect the drive with a PC. Connected between a USB connector on the PC and the RJ-45 connector on the drive.	JVOP-181	p. 39
Remote Operation LED Operator	Used for remote operation. Use the LED Operator in combination with the extension cable and the remote interface unit.	JVOP-182 Available soon	—
Support Tools (DriveWizard) Cable	Connects the drive to a PC for use with DriveWizard.	WV103	p. 39
Remote Interface Extension Cable	Required for use with the remote digital operator.	WV001: 1 m WV003: 3 m	—
RS-422/485 Interface for MEMOBUS communication	Used as an interface unit to communicate with a host controller via the RS-422 or RS-485 interface using the MEMOBUS/Modbus protocol. The communication cable connector is included with the interface unit.	SI-485/J Available soon	—
Frequency Meter, Current Meter	Allows the user to set and monitor the frequency, current, and voltage using an external device.	DCF-6A	p. 40
Frequency Setting Potentiometer (2 k $\Omega$ )		RH000739	p. 40
Frequency Meter Adjusting Potentiometer (20 k $\Omega$ )		RH000850	p. 40
Control Dial for Frequency Setting Potentiometer		CM-3S	p. 40
Output Voltage Meter		SDF-12	p. 40
NEMA 1 Kit		Turns an IP20 open-chassis design into a NEMA 1 compliant enclosure panel.	—
Attachment for External Heatsink	Mechanical kit to install the drive with the heatsink out of the cabinet. Note: Current derating must be considered when this installation method is used.	—	p. 25
DIN Rail Attachment	Allows mounting the drive on a DIN rail.	—	p. 25

Note: For delivery periods and specifications of the recommended products, contact the individual manufactures.

## ● Circuit Breaker, Magnetic Contactor

Base device selection on motor capacity.

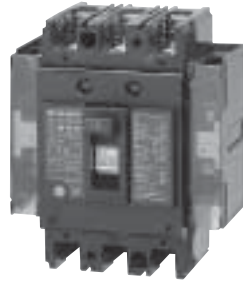

Circuit Breaker  
[Mitsubishi Electric]

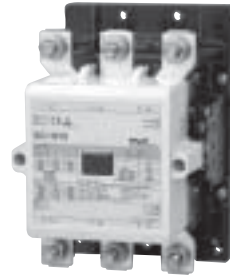

Magnetic Contactor  
[Fuji Electric]

### Three-Phase 200 V Class

Motor Capacity (kW)	Circuit Breaker				Magnetic Contactor			
	Without Reactor		With Reactor		Without Reactor		With Reactor	
	Model	Rated Current (A)	Model	Rated Current (A)	Model	Rated Current (A)	Model	Rated Current (A)
0.1	NF30	5	NF30	3	SC-03	11	SC-03	11
0.2	NF30	5	NF30	3	SC-03	11	SC-03	11
0.4	NF30	5	NF30	5	SC-03	11	SC-03	11
0.75	NF30	10	NF30	10	SC-03	11	SC-03	11
1.5	NF30	20	NF30	15	SC-4-0	18	SC-03	11
2.2	NF30	20	NF30	15	SC-N1	26	SC-4-0	18
3.7	NF30	30	NF30	20	SC-N2	35	SC-N1	26
5.5	NF50	50	NF50	40	SC-N2S	50	SC-N2	35

### Single-Phase 200 V Class

Motor Capacity (kW)	Circuit Breaker				Magnetic Contactor			
	Without Reactor		With Reactor		Without Reactor		With Reactor	
	Model	Rated Current (A)	Model	Rated Current (A)	Model	Rated Current (A)	Model	Rated Current (A)
0.1	NF30	5	NF30	3	SC-03	11	SC-03	11
0.2	NF30	5	NF30	5	SC-03	11	SC-03	11
0.4	NF30	10	NF30	10	SC-03	11	SC-03	11
0.75	NF30	20	NF30	15	SC-4-0	18	SC-4-0	18
1.5	NF30	30	NF30	30	SC-N2	35	SC-N1	26
2.2	NF30	40	NF30	30	SC-N2	35	SC-N2	35

### Three-Phase 400 V Class

Motor Capacity (kW)	Circuit Breaker				Magnetic Contactor			
	Without Reactor		With Reactor		Without Reactor		With Reactor	
	Model	Rated Current (A)	Model	Rated Current (A)	Model	Rated Current (A)	Model	Rated Current (A)
0.2	NF30	5	NF30	3	SC-03	11	SC-03	11
0.4	NF30	5	NF30	3	SC-03	11	SC-03	11
0.75	NF30	5	NF30	5	SC-03	11	SC-03	11
1.5	NF30	10	NF30	10	SC-03	11	SC-03	11
2.2	NF30	20	NF30	10	SC-4-0	18	SC-03	11
3.0	NF30	20	NF30	15	SC-4-0	18	SC-03	11
3.7	NF30	20	NF30	15	SC-N1	26	SC-4-0	18
5.5	NF30	30	NF30	20	SC-N2	35	SC-N1	26

### ● Surge Protector

Dimensions (mm)

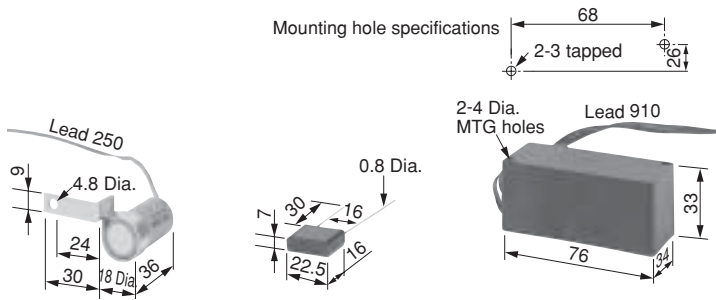

Weight: approx. 22 g  
Model: DCR2-50A22E

Weight: approx. 5 g  
Model: DCR2-10A25C

Weight: approx. 150 g  
Model: RFN3AL504KD

### Product Line [Nippon Chemi-Con Corporation]

Peripheral Devices		Surge Protector	Model	Specifications	Code No.
200 V to 230 V	Control Relay	Large-Capacity Coil (other than relay)	DCR2-50A22E	220 Vac 0.5 $\mu$ F+200 $\Omega$	C002417
		MY2, MY3 [Omron Corporation] MM2, MM4 [Omron Corporation] HH22, HH23 [Fuji Electric]	DCR2-10A25C	250 Vac 0.1 $\mu$ F+100 $\Omega$	C002482
		380 to 460 V	RFN3AL504KD	1000 Vdc 0.5 $\mu$ F+220 $\Omega$	C002630

## DC Reactor (UZDA-B for DC circuit)

Base device selection on motor capacity.

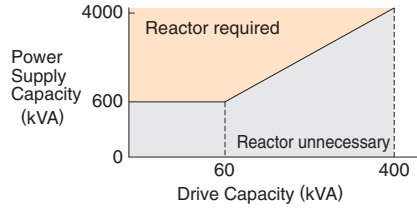
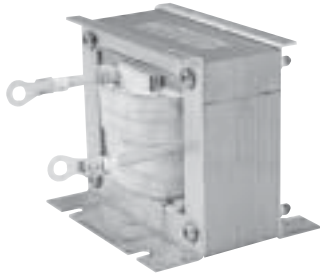

Note: Reactor recommended for power supplies larger than 600 kVA. Use an AC reactor if power supply is 0.2 kW or smaller.

### Connection Diagram

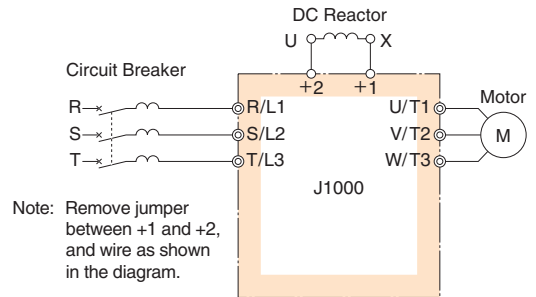

### Dimensions (mm)

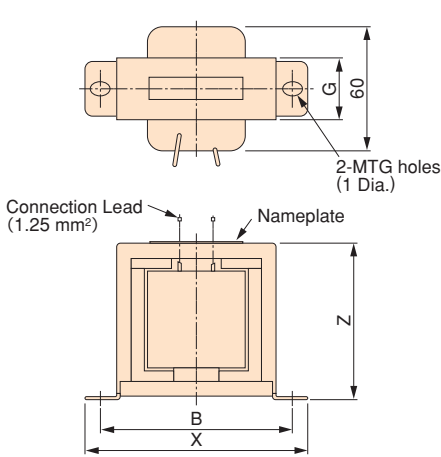

Figure 1

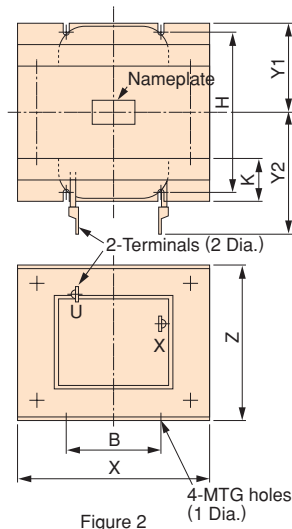

Figure 2

**Three-Phase 200 V Class** Note: Contact Yaskawa directly for information on 200 V class single-phase drives. Use an AC reactor for motor capacities 0.2 kW and smaller.

Motor Capacity (kW)	Current (A)	Inductance (mH)	Code No.	Figure	Dimensions (mm)										Weight (kg)	Watt Loss (W)	Wire Gauge* (mm <sup>2</sup> )
					X	Y2	Y1	Z	B	H	K	G	φ1	φ2			
0.4	5.4	8	X010048	1	85	-	-	53	74	-	-	32	M4	-	0.8	8	2
0.75	5.4	8	X010048	1	85	-	-	53	74	-	-	32	M4	-	0.8	8	2
1.5	18	3	X010049	2	86	80	36	76	60	55	18	-	M4	M5	2	18	5.5
2.2	18	3	X010049	2	86	80	36	76	60	55	18	-	M4	M5	2	18	5.5
3.7	18	3	X010049	2	86	80	36	76	60	55	18	-	M4	M5	2	18	5.5
5.5	36	1	X010050	2	105	90	46	93	64	80	26	-	M6	M6	3.2	22	8

### Three-Phase 400 V Class

Motor Capacity (kW)	Current (A)	Inductance (mH)	Code No.	Figure	Dimensions (mm)										Weight (kg)	Watt Loss (W)	Wire Gauge* (mm <sup>2</sup> )
					X	Y2	Y1	Z	B	H	K	G	φ1	φ2			
0.4	3.2	28	X010052	1	85	-	-	53	74	-	-	32	M4	-	0.8	9	2
0.75	3.2	28	X010052	1	85	-	-	53	74	-	-	32	M4	-	0.8	9	2
1.5	5.7	11	X010053	1	90	-	-	60	80	-	-	32	M4	-	1	11	2
2.2	5.7	11	X010053	1	90	-	-	60	80	-	-	32	M4	-	1	11	2
3.0	12	6.3	X010054	2	86	80	36	76	60	55	18	-	M4	M5	2	16	2
3.7	12	6.3	X010054	2	86	80	36	76	60	55	18	-	M4	M5	2	16	2
5.5	23	3.6	X010055	2	105	90	46	93	64	80	26	-	M6	M5	3.2	27	5.5

\*: Cable: IV, 75°C, ambient temperature 45°C, 3 lines max.

# J Peripheral Devices and Options (continued)

## AC Reactor (UZBA-B for Input 50/60 Hz)

Base device selection on motor capacity.

### Connection Diagram

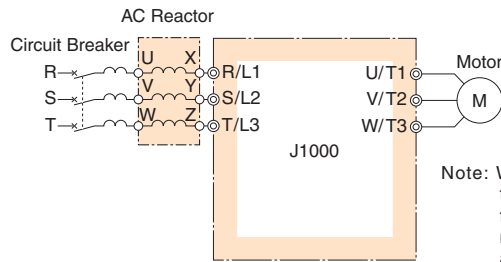

Note: When using low noise type drives (high-carrier frequency of 2.5 kHz or more), do not connect an AC reactor to the output side (U, V, W) of the drive.

### Dimensions (mm)

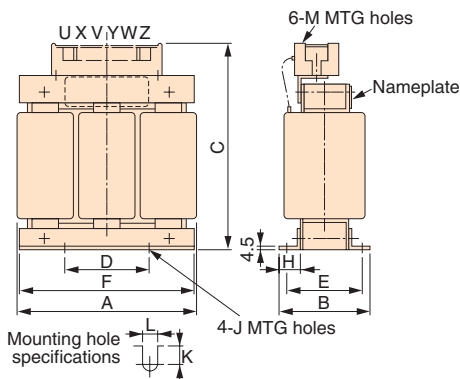

Figure 1

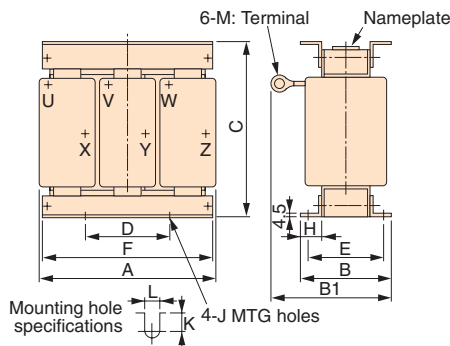

Figure 2

### Three-Phase 200 V Class Note: For the 200 V class single-phase input series, contact us for inquiry.

Motor Capacity (kW)	Current (A)	Inductance (mH)	Code No.	Figure	Dimensions (mm)											Weight (kg)	Watt Loss (W)	
					A	B	B1	C	D	E	F	H	J	K	L			M
0.1	2	7	X002764	1	120	71	-	120	40	50	105	20	M6	10.5	7	M4	2.5	15
0.2	2	7	X002764	1	120	71	-	120	40	50	105	20	M6	10.5	7	M4	2.5	15
0.4	2.5	4.2	X002553	1	120	71	-	120	40	50	105	20	M6	10.5	7	M4	2.5	15
0.75	5	2.1	X002554	1	120	71	-	120	40	50	105	20	M6	10.5	7	M4	2.5	15
1.5	10	1.1	X002489	1	130	88	-	130	50	70	130	22	M6	11.5	7	M4	3	25
2.2	15	0.71	X002490	1	130	88	-	130	50	70	130	22	M6	11.5	7	M4	3	30
3.7	20	0.53	X002491	2	130	88	114	105	50	70	130	22	M6	11.5	7	M5	3	35
5.5	30	0.35	X002492	2	130	88	119	105	50	70	130	22	M6	9	7	M5	3	45

### Three-Phase 400 V Class

Motor Capacity (kW)	Current (A)	Inductance (mH)	Code No.	Figure	Dimensions (mm)											Weight (kg)	Watt Loss (W)	
					A	B	B1	C	D	E	F	H	J	K	L			M
0.2	1.3	18	X002561	1	120	71	-	120	40	50	105	20	M6	10.5	7	M4	2.5	15
0.4	1.3	18	X002561	1	120	71	-	120	40	50	105	20	M6	10.5	7	M4	2.5	15
0.75	2.5	8.4	X002562	1	120	71	-	120	40	50	105	20	M6	10.5	7	M4	2.5	15
1.5	5	4.2	X002563	1	130	88	-	130	50	70	130	22	M6	9	7	M4	3	25
2.2	7.5	3.6	X002564	1	130	88	-	130	50	70	130	22	M6	9	7	M4	3	35
3.0	10	2.2	X002500	1	130	88	-	130	50	70	130	22	M6	11.5	7	M4	3	40
3.7	10	2.2	X002500	1	130	88	-	130	50	70	130	22	M6	11.5	7	M4	3	40
5.5	15	1.42	X002501	1	130	98	-	130	50	80	130	22	M6	11.5	7	M4	4	50

## Zero Phase Reactor

Base device selection on motor capacity.

### Finemet Zero-Phase Reactor to Reduce Radio Noise [Hitachi Metals, Ltd.]

Note: Finemet is a registered trademark of Hitachi Metals, Ltd.



#### Connection Diagram

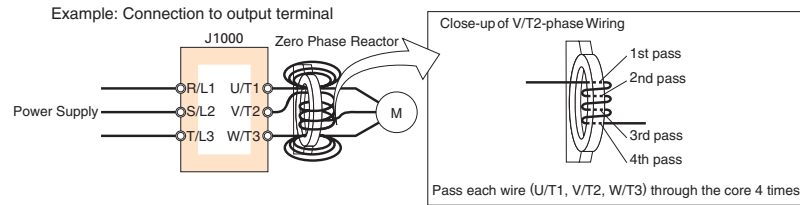

#### Dimensions (mm)

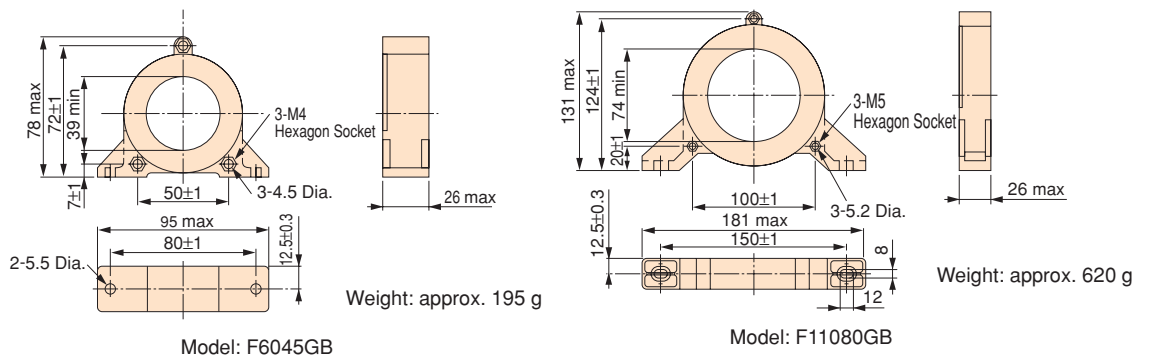

#### Three-Phase 200 V Class

J1000		Zero Phase Reactor		
Motor Capacity (kW)	Recommended Gauge (mm <sup>2</sup> )	Model	Code No.	Qty.
0.1	2	F6045GB	FIL001098	1
0.2	2	F6045GB	FIL001098	1
0.4	2	F6045GB	FIL001098	1
0.75	2	F6045GB	FIL001098	1
1.5	2	F6045GB	FIL001098	1
2.2	3.5	F6045GB	FIL001098	1
3.7	5.5	F6045GB	FIL001098	1
5.5	8	F11080GB	FIL001097	1

#### Three-Phase 400 V Class

J1000		Zero Phase Reactor		
Motor Capacity (kW)	Recommended Gauge (mm <sup>2</sup> )	Model	Code No.	Qty.
0.2	2	F6045GB	FIL001098	1
0.4	2	F6045GB	FIL001098	1
0.75	2	F6045GB	FIL001098	1
1.5	2	F6045GB	FIL001098	1
2.2	2	F6045GB	FIL001098	1
3.0	2	F6045GB	FIL001098	1
3.7	2	F6045GB	FIL001098	1
5.5	5.5	F6045GB	FIL001098	1

#### Single-Phase 200 V Class

J1000		Zero Phase Reactor		
Motor Capacity (kW)	Recommended Gauge (mm <sup>2</sup> )	Model	Code No.	Qty.
0.1	2	F6045GB	FIL001098	1
0.2	2	F6045GB	FIL001098	1
0.4	2	F6045GB	FIL001098	1
0.75	2	F6045GB	FIL001098	1
1.5	3.5	F6045GB	FIL001098	1
2.2	5.5	F6045GB	FIL001098	1

## Fuse/Fuse Holder

Install a fuse to the drive input terminals to prevent damage in case a fault occurs.

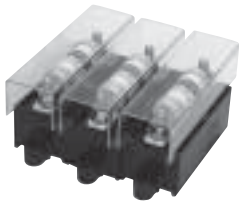

[Fuji Electric]

Dimensions (mm)

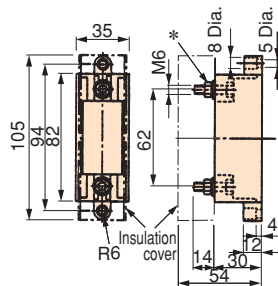

Figure 1

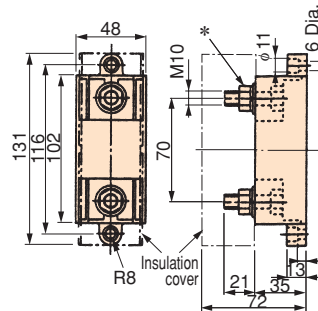

Figure 2

\*: Mounting components supplied separately. Tighten bolt when fuse is installed.

### Three-Phase 200 V Class

CIMR-JA:.....	Fuse			Fuse Holder			
	Model	Code No.	Qty.	Model	Code No.	Qty.	Figure
2A0001	CR6L-20/UL	FU002087	3	CMS-4	FU002091	3	1
2A0002	CR6L-20/UL	FU002087	3				
2A0004	CR6L-20/UL	FU002087	3				
2A0006	CR6L-30/UL	FU002088	3				
2A0008	CR6L-50/UL	FU000935	3				
2A0010	CR6L-50/UL	FU000935	3				
2A0012	CR6L-50/UL	FU000935	3	CMS-5	FU002092	3	2
2A0018	CR6L-75/UL	FU002089	3				
2A0020	CR6L-75/UL	FU002089	3				

### Single-Phase 200 V Class

CIMR-JA:.....	Fuse			Fuse Holder			
	Model	Code No.	Qty.	Model	Code No.	Qty.	Figure
BA0001	CR6L-20/UL	FU002087	2	CMS-4	FU002091	2	1
BA0002	CR6L-30/UL	FU002088	2				
BA0003	CR6L-50/UL	FU000935	2				
BA0006	CR6L-75/UL	FU002089	2	CMS-5	FU002092	2	2
BA0010	CR6L-100/UL	FU000927	2				

### Three-Phase 400 V Class

CIMR-JA:.....	Fuse			Fuse Holder			
	Model	Code No.	Qty.	Model	Code No.	Qty.	Figure
4A0001	CR6L-20/UL	FU002087	3	CMS-4	FU002091	3	1
4A0002	CR6L-20/UL	FU002087	3				
4A0004	CR6L-50/UL	FU000935	3				
4A0005	CR6L-50/UL	FU000935	3				
4A0007	CR6L-50/UL	FU000935	3				
4A0009	CR6L-50/UL	FU000935	3				
4A0011	CR6L-50/UL	FU000935	3				

## Capacitor-type Noise Filter

Capacitor-type noise filter exclusively designed for drive input.

The noise filter can be used in combination with a zero-phase reactor. For both 200 V and 400 V classes.

Note: The capacitor-type noise filter can be used for drive input only. Do not connect the noise filter to the output terminals.



[Okaya Electric Industries]

Connection Diagram

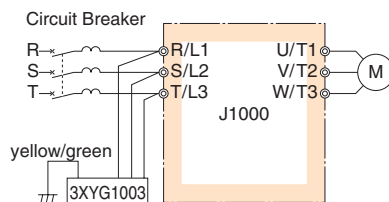

Dimensions (mm)

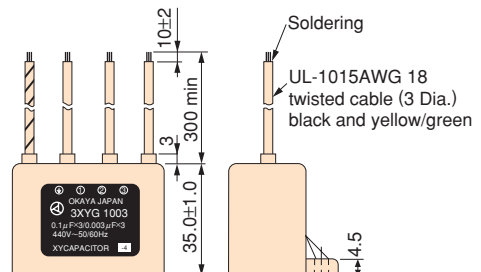
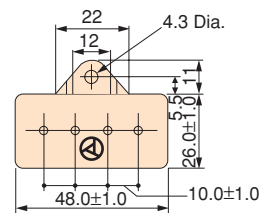

Specifications

Rated Voltage	Capacitance (3 devices each)	Operating Temperature Range (°C)
440 V	X (Δ connection) : 0.1 μF±20 % Y (λ connection) : 0.003 μF±20 %	-40 to +85

Note: For use with 460 V and 480 V units, contact Yaskawa directly.



# Input Noise Filter without Case

Base device selection on motor capacity.

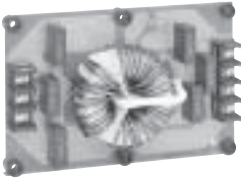

Note: Contact Yaskawa for CE compliant models (EMC directive).

## Connection Diagram

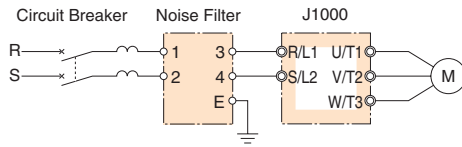

Single-Phase Input (LNFB Type)

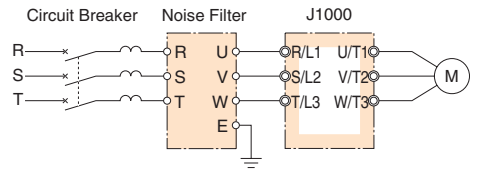

Three-Phase Input (LNFD Type)

Note: Do not connect the input noise filter to the drive output terminals (U, V, W).  
Connect in parallel when using two filters.

## Dimensions

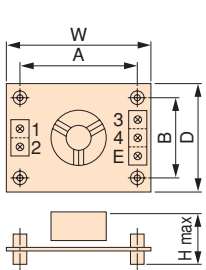

Figure 1 (Single-Phase)

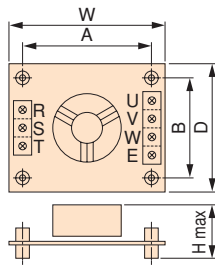

Figure 2 (Three-Phase)

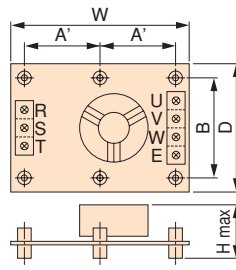

Figure 3 (Three-Phase)

## Three-Phase 200 V Class

Motor Capacity (kW)	Model	Code No.	Qty.	Rated Current (A)	Figure	Dimensions (mm)						Mounting Screw	Weight (kg)
						W	D	H	A	A'	B		
0.1	LNFD-2103DY	FIL000132	1	10	2	120	80	55	108	–	68	M4×4, 20 mm	0.2
0.2	LNFD-2103DY	FIL000132	1	10	2	120	80	55	108	–	68	M4×4, 20 mm	0.2
0.4	LNFD-2103DY	FIL000132	1	10	2	120	80	55	108	–	68	M4×4, 20 mm	0.2
0.75	LNFD-2103DY	FIL000132	1	10	2	120	80	55	108	–	68	M4×4, 20 mm	0.2
1.5	LNFD-2153DY	FIL000133	1	15	2	120	80	55	108	–	68	M4×4, 20 mm	0.2
2.2	LNFD-2203DY	FIL000134	1	20	2	170	90	70	158	–	78	M4×4, 20 mm	0.4
3.7	LNFD-2303DY	FIL000135	1	30	3	170	110	70	–	79	98	M4×6, 20 mm	0.5
5.5	LNFD-2203DY	FIL000134	2	40	2	170	90	70	158	–	78	M4×4, 20 mm	0.4

## Single-Phase 200 V Class

Motor Capacity (kW)	Model	Code No.	Qty.	Rated Current (A)	Figure	Dimensions (mm)						Mounting Screw	Weight (kg)
						W	D	H	A	A'	B		
0.1	LNFB-2102DY	FIL000128	1	10	1	120	80	50	108	–	68	M4×4, 20 mm	0.1
0.2	LNFB-2102DY	FIL000128	1	10	1	120	80	50	108	–	68	M4×4, 20 mm	0.2
0.4	LNFB-2152DY	FIL000129	1	15	1	120	80	50	108	–	68	M4×4, 20 mm	0.2
0.75	LNFB-2202DY	FIL000130	1	20	1	120	80	50	108	–	68	M4×4, 20 mm	0.2
1.5	LNFB-2302DY	FIL000131	1	30	1	130	90	65	118	–	78	M4×4, 20 mm	0.3
2.2	LNFB-2202DY	FIL000130	2	40	1	120	80	50	108	–	68	M4×4, 20 mm	0.2

## Three-Phase 400 V Class

Motor Capacity (kW)	Model	Code No.	Qty.	Rated Current (A)	Figure	Dimensions (mm)						Mounting Screw	Weight (kg)
						W	D	H	A	A'	B		
0.2	LNFD-4053DY	FIL000144	1	5	3	170	130	75	–	79	118	M4×6, 30 mm	0.3
0.4	LNFD-4053DY	FIL000144	1	5	3	170	130	75	–	79	118	M4×6, 30 mm	0.3
0.75	LNFD-4053DY	FIL000144	1	5	3	170	130	75	–	79	118	M4×6, 30 mm	0.3
1.5	LNFD-4103DY	FIL000145	1	10	3	170	130	95	–	79	118	M4×6, 30 mm	0.4
2.2	LNFD-4103DY	FIL000145	1	10	3	170	130	95	–	79	118	M4×6, 30 mm	0.4
3.0	LNFD-4153DY	FIL000146	1	15	3	170	130	95	–	79	118	M4×6, 30 mm	0.4
3.7	LNFD-4153DY	FIL000146	1	15	3	170	130	95	–	79	118	M4×6, 30 mm	0.4
5.5	LNFD-4203DY	FIL000147	1	20	3	200	145	100	–	94	133	M4×4, 30 mm	0.5

### Input Noise Filter with Case

Base device selection on motor capacity.



Note: Contact Yaskawa for CE compliant models (EMC directive).

#### Connection Diagram

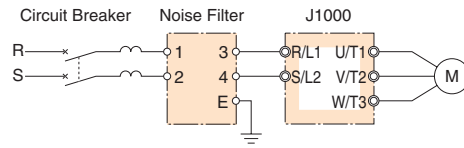

#### Single-Phase Input (LNFB Type)

Note: Connect in parallel when using two filters.

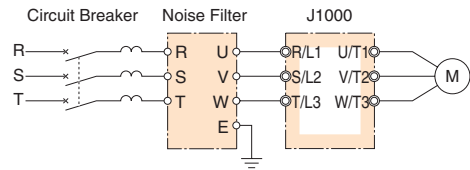

#### Three-Phase Input (LNFD Type)

#### Dimensions (mm)

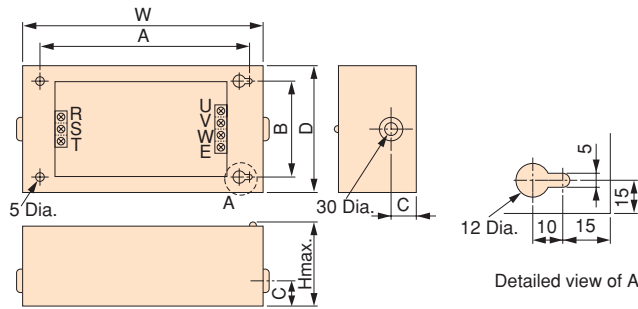

Example of three-phase input.

#### Three-Phase 200 V Class

Motor Capacity (kW)	Model	Code No.	Qty.	Rated Current (A)	Dimensions (mm)						Mounting Screw	Weight (kg)
					W	D	H	A	B	C		
0.1	LNFD-2103HY	FIL000140	1	10	185	95	85	155	65	33	M4×4, 10 mm	0.9
0.2	LNFD-2103HY	FIL000140	1	10	185	95	85	155	65	33	M4×4, 10 mm	0.9
0.4	LNFD-2103HY	FIL000140	1	10	185	95	85	155	65	33	M4×4, 10 mm	0.9
0.75	LNFD-2103HY	FIL000140	1	10	185	95	85	155	65	33	M4×4, 10 mm	0.9
1.5	LNFD-2153HY	FIL000141	1	15	185	95	85	155	65	33	M4×4, 10 mm	0.9
2.2	LNFD-2203HY	FIL000142	1	20	240	125	100	210	95	33	M4×4, 10 mm	1.5
3.7	LNFD-2303HY	FIL000143	1	30	240	125	100	210	95	33	M4×4, 10 mm	1.6
5.5	LNFD-2203HY	FIL000142	2	40	240	125	100	210	95	33	M4×4, 10 mm	1.5

#### Single-Phase 200 V Class

Motor Capacity (kW)	Model	Code No.	Qty.	Rated Current (A)	Dimensions (mm)						Mounting Screw	Weight (kg)
					W	D	H	A	B	C		
0.1	LNFB-2102HY	FIL000136	1	10	185	95	85	155	65	33	M4×4, 10 mm	0.8
0.2	LNFB-2102HY	FIL000136	1	10	185	95	85	155	65	33	M4×4, 10 mm	0.8
0.4	LNFB-2152HY	FIL000137	1	15	185	95	85	155	65	33	M4×4, 10 mm	0.8
0.75	LNFB-2202HY	FIL000138	1	20	185	95	85	155	65	33	M4×4, 10 mm	0.9
1.5	LNFB-2302HY	FIL000139	1	30	200	105	95	170	75	33	M4×4, 10 mm	1.1
2.2	LNFB-2202HY	FIL000138	2	40	185	95	85	155	65	33	M4×4, 10 mm	0.9

#### Three-Phase 400 V Class

Motor Capacity (kW)	Model	Code No.	Qty.	Rated Current (A)	Dimensions (mm)						Mounting Screw	Weight (kg)
					W	D	H	A	B	C		
0.2	LNFD-4053HY	FIL000149	1	5	235	140	120	205	110	43	M4×4, 10 mm	1.6
0.4	LNFD-4053HY	FIL000149	1	5	235	140	120	205	110	43	M4×4, 10 mm	1.6
0.75	LNFD-4053HY	FIL000149	1	5	235	140	120	205	110	43	M4×4, 10 mm	1.6
1.5	LNFD-4103HY	FIL000150	1	10	235	140	120	205	110	43	M4×4, 10 mm	1.7
2.2	LNFD-4103HY	FIL000150	1	10	235	140	120	205	110	43	M4×4, 10 mm	1.7
3.0	LNFD-4153HY	FIL000151	1	15	235	140	120	205	110	43	M4×4, 10 mm	1.7
3.7	LNFD-4153HY	FIL000151	1	15	235	140	120	205	110	43	M4×4, 10 mm	1.7
5.5	LNFD-4203HY	FIL000152	1	20	270	155	125	240	125	43	M4×4, 10 mm	2.2

## Output Noise Filter

Base device selection on motor capacity.



[NEC TOKIN Corporation]

Connection Diagram

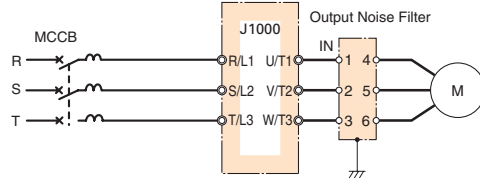

Dimensions

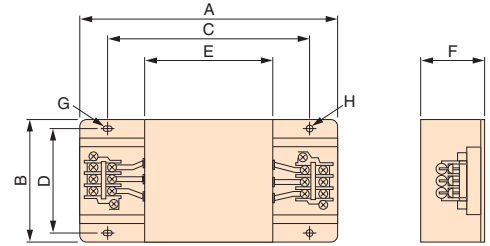

### Three/Single-Phase 200 V Class

Motor Capacity (kW)	Model	Code No.	Qty.	Rated Current (A)	Dimensions (mm)								Mounting Screw	Weight (kg)
					A	B	C	D	E	F	G	H		
0.1	LF-310KA	FIL000068	1	10	140	100	100	90	70	45	7 × φ4.5	φ4.5	TE-K5.5M4	0.5
0.2	LF-310KA	FIL000068	1	10	140	100	100	90	70	45	7 × φ4.5	φ4.5	TE-K5.5M4	0.5
0.4	LF-310KA	FIL000068	1	10	140	100	100	90	70	45	7 × φ4.5	φ4.5	TE-K5.5M4	0.5
0.75	LF-310KA	FIL000068	1	10	140	100	100	90	70	45	7 × φ4.5	φ4.5	TE-K5.5M4	0.5
1.5	LF-310KA	FIL000068	1	10	140	100	100	90	70	45	7 × φ4.5	φ4.5	TE-K5.5M4	0.5
2.2	LF-320KA	FIL000069	1	20	140	100	100	90	70	45	7 × φ4.5	φ4.5	TE-K5.5M4	0.6
3.7	LF-320KA	FIL000069	1	20	140	100	100	90	70	45	7 × φ4.5	φ4.5	TE-K5.5M4	0.6
5.5	LF-350KA	FIL000070	1	50	260	180	180	160	120	65	7 × φ4.5	φ4.5	TE-K22M6	2

### Three-Phase 400 V Class

Motor Capacity (kW)	Model	Code No.	Qty.	Rated Current (A)	Dimensions (mm)								Mounting Screw	Weight (kg)
					A	B	C	D	E	F	G	H		
0.2	LF-310KB	FIL000071	1	10	140	100	100	90	70	45	7 × φ4.5	φ4.5	TE-K5.5M4	0.5
0.4	LF-310KB	FIL000071	1	10	140	100	100	90	70	45	7 × φ4.5	φ4.5	TE-K5.5M4	0.5
0.75	LF-310KB	FIL000071	1	10	140	100	100	90	70	45	7 × φ4.5	φ4.5	TE-K5.5M4	0.5
1.5	LF-310KB	FIL000071	1	10	140	100	100	90	70	45	7 × φ4.5	φ4.5	TE-K5.5M4	0.5
2.2	LF-310KB	FIL000071	1	10	140	100	100	90	70	45	7 × φ4.5	φ4.5	TE-K5.5M4	0.5
3	LF-310KB	FIL000071	1	10	140	100	100	90	70	45	7 × φ4.5	φ4.5	TE-K5.5M4	0.5
3.7	LF-310KB	FIL000071	1	10	140	100	100	90	70	45	7 × φ4.5	φ4.5	TE-K5.5M4	0.5
5.5	LF-320KB	FIL000072	1	20	140	100	100	90	70	45	7 × φ4.5	φ4.5	TE-K5.5M4	0.6

### ● Isolator (Insulation Type DC Transmission Converter)



Connection Diagram

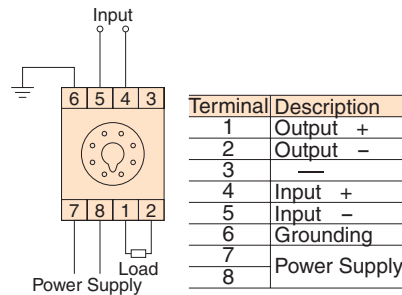

Cable Length

- 4 to 20 mA: within 100 m
- 0 to 10 V: within 50 m

#### Dimensions (mm)

Model GP Series

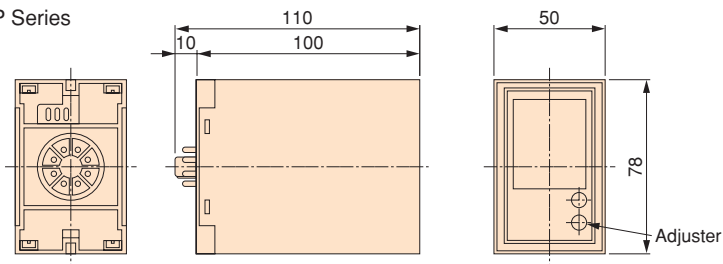

#### Socket

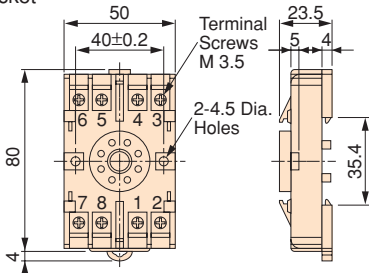

#### View of Socket Mounting

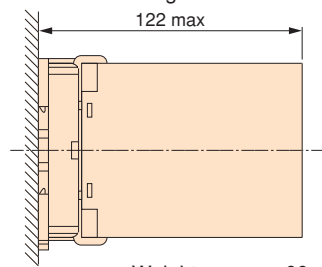

#### Performance

- |                                 |   |
|---------------------------------|---|
| (1) Allowance                   | $\pm 0.25\%$ of output span (ambient temp.: 23°C)                                   |
| (2) Temperature Influence       | With $\pm 0.25\%$ of output span (at $\pm 10^\circ\text{C}$ of ambient temperature) |
| (3) Aux. Power Supply Influence | With $\pm 0.1\%$ of output span (at $\pm 10\%$ of aux. power supply)                |
| (4) Load Resistance Influence   | With $\pm 0.05\%$ of output span (in the range of load resistance)                  |
| (5) Output Ripple               | With $\pm 0.5\%$ P-P of output span   |
| (6) Response Time               | 0.5 s or less (time to settle to $\pm 1\%$ of final steady value)                   |
| (7) Withstand Voltage           | 2000 Vac for 60 s (between all terminals and enclosure)                             |
| (8) Insulation Resistance       | 20 M $\Omega$ and above (using 500 Vdc megger between each terminal and enclosure)  |

#### Product Line

Model	Input Signal	Output Signal	Power Supply	Code No.
DGP2-4-4	0 to 10 V	0 to 10 V	AC 100 V	CON 000019.25
DGP2-4-8	0 to 10 V	4 to 20 mA	AC 100 V	CON 000019.26
DGP2-8-4	4 to 20 mA	0 to 10 V	AC 100 V	CON 000019.35
DGP2-3-4	0 to 5 V	0 to 10 V	AC 100 V	CON 000019.15
DGP3-4-4	0 to 10 V	0 to 10 V	AC 200 V	CON 000020.25
DGP3-4-8	0 to 10 V	4 to 20 mA	AC 200 V	CON 000020.26
DGP3-8-4	4 to 20 mA	0 to 10 V	AC 200 V	CON 000020.35
DGP3-3-4	0 to 5 V	0 to 10 V	AC 200 V	CON 000020.15

# Braking Resistor, Braking Resistor Unit

Base device selection on motor capacity.



Braking Resistor



Braking Resistor Unit

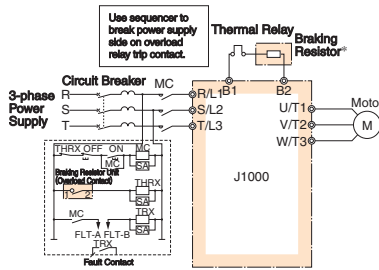

Diagram A

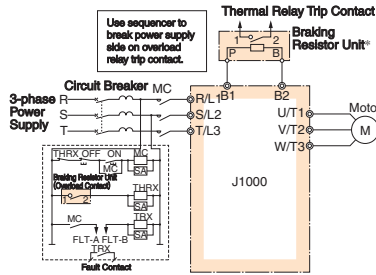

Diagram B

\*: To use the optional braking resistor, disable the deceleration stall prevention function (L3-04 = 0). If you use the braking resistor without changing this parameter, the motor may not stop within the specified deceleration time.

Note: 1. The duty factor is intended for ramping to stop under constant-torque load. If constant output or continuous regenerative braking force is provided, the duty factor will be reduced.

2. For applications with large regenerative power, the standard combination of the braking unit and the braking resistor may not provide sufficient capacity.

If braking torque may exceed the value given in the table below, contact us for inquiry.

## Standard Specifications and Applications (200 V/400 V class)

### Three/Single-Phase 200 V Class

Max. Motor Capacity (kW)	ND/HD	J1000		Braking Resistor				Braking Resistor Unit				Min. Connection Resistance (Ω)		
		Three-Phase CIMR-JA2A	Single-Phase CIMR-JABA	Model ERF-150WJ	Resistance (Ω)	Qty.	Diagram	Braking Torque (%) (3%ED)	Model LKEB	Resistor Specifications (per unit)	Qty.		Diagram	Braking Torque (%) (10%ED)
0.1	HD	0001	0001	401	400	1	A	220	40P7	70 W 750 Ω	1	B	220	300
	ND	0001	0001											
0.2	HD	0002	0002	401	400	1	A	220	40P7	70 W 750 Ω	1	B	125	300
	ND	0002	0002											
0.4	HD	0004	0003	201	200	1	A	220	20P7	70 W 200 Ω	1	B	220	200
	ND	0004	0003											
0.75	HD	0006	0006	201	200	1	A	125	20P7	70 W 200 Ω	1	B	125	200
	ND	0006	0006											
1.1	HD	0008	-	101	100	1	A	170	21P5	260 W 100 Ω	1	B	170	120
	ND	0008	-											
1.5	HD	0010	0010	101	100	1	A	125	21P5	260 W 100 Ω	1	B	125	60
	ND	0010	0010											
2.2	HD	0012	-	700	70	1	A	120	22P2	260 W 70 Ω	1	B	120	60
	ND	0012	-											
3.0	HD	0018	-	620	62	1	A	100	23P7	390 W 40 Ω	1	B	150	32
	ND	0018	-											
3.7	HD	0020	-	620	62	1	A	80	23P7	390 W 40 Ω	1	B	125	32
	ND	0020	-											
5.5	ND	0020	-	-	-	-	-	-	23P7	390 W 40 Ω	1	B	85	32

### Three-Phase 400 V Class

Max. Motor Capacity (kW)	ND/HD	J1000		Braking Resistor				Braking Resistor Unit				Min. Connection Resistance (Ω)	
		Three-Phase CIMR-JA4A	Model ERF-150WJ	Resistance (Ω)	Qty.	Diagram	Braking Torque (%) (3%ED)	Model LKEB	Resistor Specifications (per unit)	Qty.	Diagram		Braking Torque (%) (10%ED)
0.2	HD	0001	751	750	1	A	230	40P7	70 W 750 Ω	1	B	230	750
0.4	ND	0001											
0.75	HD	0002	751	750	1	A	230	40P7	70 W 750 Ω	1	B	230	750
	ND	0002											
1.5	HD	0004	751	750	1	A	130	40P7	70 W 750 Ω	1	B	130	510
	ND	0004											
2.2	HD	0005	401	400	1	A	125	41P5	260 W 400 Ω	1	B	125	240
	ND	0005											
3.0	HD	0007	301	300	1	A	115	42P2	260 W 250 Ω	1	B	135	200
	ND	0007											
3.7	HD	0009	401	400	2	A	125	43P7	390 W 150 Ω	1	B	165	100
	ND	0009											
5.5	HD	0011	401	400	2	A	105	43P7	390 W 150 Ω	1	B	135	100
	ND	0011											
5.5	ND	0011	-	-	-	-	-	45P5	520 W 100 Ω	1	B	135	100

### Braking Resistor, Braking Resistor Unit (continued)

#### Braking Resistor Dimensions (mm)

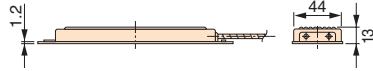
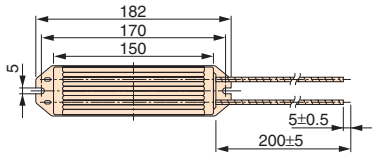

Weight: approx. 0.2 kg  
(All ERF-150WJ Series models)

#### Braking Resistor Unit Dimensions (mm)

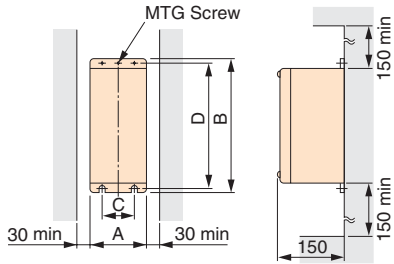

Applicable Voltage Class	Braking Resistor Unit Model LKEB-□□□□□□□□	Dimensions (mm)					Mounting Screw	Weight (kg)	Allowable Average Power Consumption (W)
		A	B	C	D				
200 V Class	20P7	105	275	50	260	M5×3	3.0	30	
	21P5	130	350	75	335	M5×4	4.5	60	
	22P2	130	350	75	335	M5×4	4.5	89	
	23P7	130	350	75	335	M5×4	5.0	150	
	25P5	250	350	200	335	M6×4	7.5	220	
400 V Class	40P7	105	275	50	260	M5×3	3.0	30	
	41P5	130	350	75	335	M5×4	4.5	60	
	42P2	130	350	75	335	M5×4	4.5	89	
	43P7	130	350	75	335	M5×4	5.0	150	
	45P5	250	350	200	335	M6×4	7.5	220	

● **RS-232C Interface for remote operator (Model: SI-232/J)**

For remote operation with the LED Operator, or for operation with DriveWizard Plus, use this interface unit.

Model	Code No.
SI-232/J	100-041-094

**Dimensions (mm)**

For SI-232/J and SI-232/JC

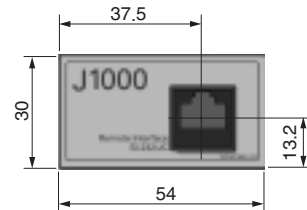

● **RS-232C Interface for copy unit/PC communication (Model: SI-232/JC)**

To use the USB copy unit, the LED Operator as a copy unit, or DriveWizard Plus, use this detachable interface unit.

Model	Code No.
SI-232/JC	100-041-095

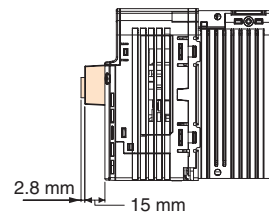

Note: Increases drive depth 17.8 mm.

● **USB Copy Unit (Model: JVOP-181)**

The copy unit is used to copy parameter settings, or serves as a DriveWizard cable to connect the drive with a PC. (Connected between a USB connector on the PC and the RJ-45 connector on the drive.)

Model	Code No.
JVOP-181	100-038-281

Note: JVOP-181 is a set consisting of a USB copy unit, RJ-45 cable, and USB cable.

**Specifications**

Item	Specifications
Port	LAN (RJ-45) USB (Ver.2.0 compatible)
Power Supply	Supplied from a PC or the drive
Operating System	Windows2000/XP
Memory	Memorizes the parameters for one drive.
Dimensions	30 (W) × 80 (H) × 20 (D) mm
Included	RJ-45 cable (1 m), USB cable (30 cm)

Note: 1. Drives must have identical software versions to copy parameters settings.  
2. Requires a USB driver available free of charge at [www.e-mechatronics.com](http://www.e-mechatronics.com).  
3. Parameter copy function disabled when connected to a PC.

**Connection**

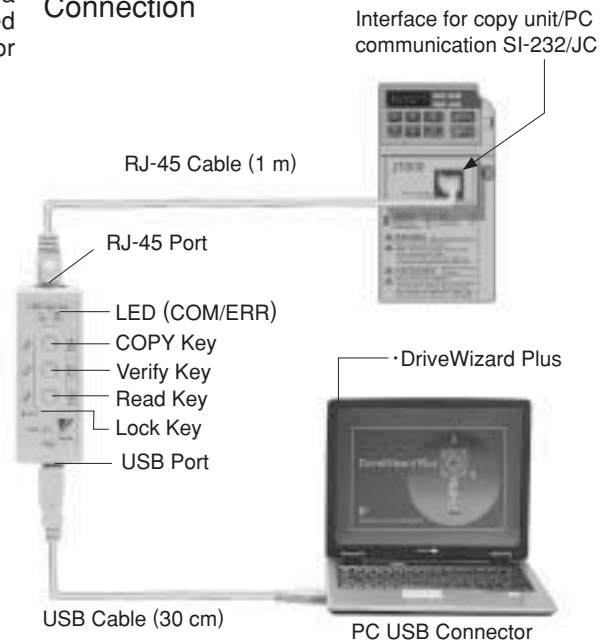

● **PC Cable (Model: WV103)**

Model	Code No.
WV103	WV103

**Specifications**

Item	Specifications
Connector	DSUB9P
Cable Length	3 m

Note: DriveWizard Plus is a PC software package for managing parameters and functions in Yaskawa drives. Available free of charge at [www.e-mechatronics.com](http://www.e-mechatronics.com).

**Connection**

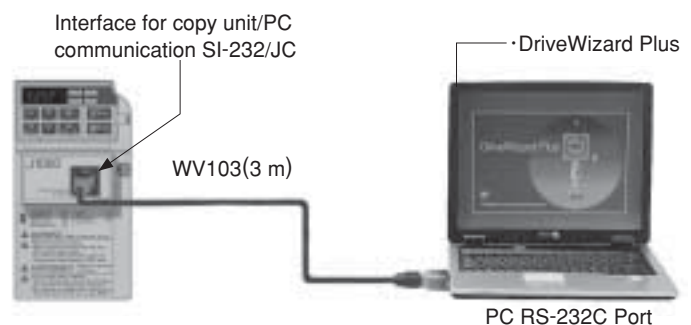

## Frequency Meter/Current Meter



Model	Code No.
Scale-75 Hz full-scale: DCF-6A	FM000065
Scale-60/120 Hz full-scale: DCF-6A	FM000085
Scale-5 A full-scale: DCF-6A	DCF-6A-5A
Scale-10 A full-scale: DCF-6A	DCF-6A-10A
Scale-20 A full-scale: DCF-6A	DCF-6A-20A
Scale-30 A full-scale: DCF-6A	DCF-6A-30A
Scale-50 A full-scale: DCF-6A	DCF-6A-50A

Note: DCF-6A is 3 V, 1 mA, 3 kΩ. For J1000 multi-function analog monitor output, set frequency potentiometer or parameter H4-02 (multi-function analog output terminal AM gain) within 0 to 3 V (default is 0 to 10 V).

### Dimensions (mm)

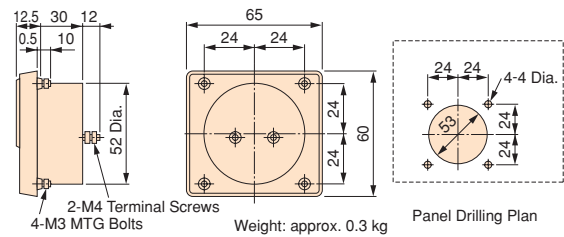

## Frequency Setting Potentiometer/Frequency Meter Adjusting Potentiometer

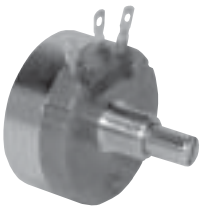

Model	Code No.
RV30YN20S 2 kΩ	RH000739
RV30YN20S 20 kΩ	FM000850

### Dimensions (mm)

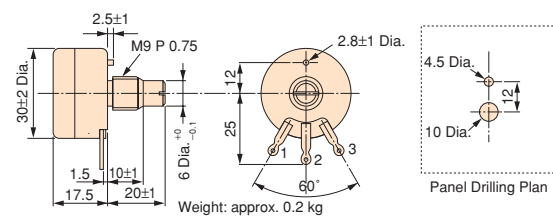

## Control Dial for Frequency Setting Potentiometer/Frequency Meter Adjusting Potentiometer



Model	Code No.
CM-3S	HLNZ-0036

### Dimensions (mm)

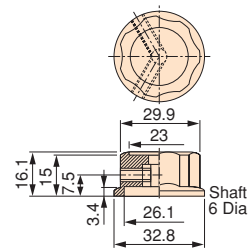

## Meter Plate for Frequency Setting Potentiometer/Frequency Meter Adjusting Potentiometer



Model	Code No.
NPJT41561-1	NPJT41561-1

### Dimensions (mm)

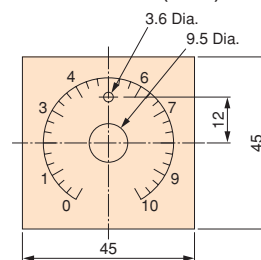

## Output Voltage Meter



Model	Code No.
Scale-300 V full-scale(Rectification Type Class 2.5) : SCF-12NH	VM000481
Scale-600 V full-scale(Rectification Type Class 2.5) : SCF-12NH	VM000502
600 V Transformer for Instrument : UPN-15B 400 V/100 V*	VM000481

\*: For use with a meter transformer

A general meter transformer may not be applicable to the drive output voltage. Select a meter transformer specifically designed for the drive output (PT000084), or a direct-reading type voltmeter that does not use a transformer.

### Dimensions (mm)

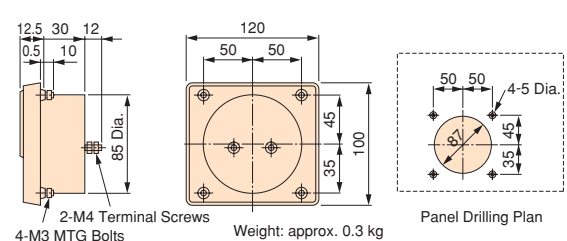



## Application Notes

### Selection

#### ■ Installing a Reactor

An AC or DC reactor can be used for the following:

- to suppress harmonic current.
- to smooth peak current that results from capacitor switching.
- when the power supply is above 600 kVA.
- when the drive is running from a power supply system with thyristor converters.

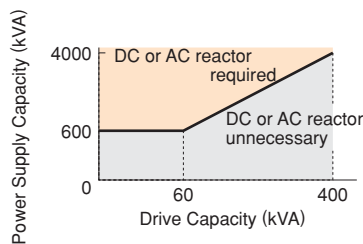

#### ■ Drive Capacity

When running a specialized motor or more than one motor in parallel from a single drive, the capacity of the drive should be larger than 1.1 times of the total motor rated current.

#### ■ Starting Torque

The overload rating for the drive determines the starting and accelerating characteristics of the motor. Expect lower torque than when running from line power. To get more starting torque, use a larger drive or increase both the motor and drive capacity.

#### ■ Emergency Stop

When the drive faults out, a protective circuit is activated and drive output is shut off. This, however, does not stop the motor immediately. Some type of mechanical brake may be needed if it is necessary to halt the motor faster than the Fast Stop function is able to.

#### ■ Repetitive Starting/Stopping

Conveyors, shutters and other such applications with frequent starts and stops often exceed 150% of their rated current values. Heat stress generated from repetitive high current can shorten the lifespan of the IGBTs. The expected lifespan for the IGBTs is about 8 million start and stop cycles with a 4 kHz carrier frequency and a 150% peak current.

Yaskawa recommends lowering the carrier frequency, particularly when audible noise is not a concern. The user can also choose to reduce the load, increase the acceleration and deceleration times, or switch to a larger drive. This will help keep peak current levels under 150%. Be sure to check the peak current levels when starting and stopping repeatedly during the initial test run, and make adjustments accordingly.

### Installation

#### ■ Enclosure Panels

Keep the drive in a clean environment by either selecting an area free of airborne dust, lint, and oil mist, or install the drive in an enclosure panel. Be sure to leave the required space between the drives to provide for cooling, and that proper measures are taken so that the ambient temperature remains within allowable limits. Keep flammable materials away from the drive. If the drive must be used in an area where it is subjected to oil mist and excessive vibration, protective designs are available. Contact Yaskawa for details.

#### ■ Installation Direction

The drive should be installed upright as specified in the manual.

### Settings

#### ■ Upper Limits

Because the drive is capable of running the motor at up to 400 Hz, be sure to set the upper limit for the frequency to control the maximum speed. The default setting for the maximum output frequency is 60 Hz.

#### ■ DC Injection Braking

Motor overheat can result if there is too much current used during DC Injection Braking, or if the time for DC Injection Braking is too long.

#### ■ Acceleration/Deceleration Times

Acceleration and deceleration times are affected by how much torque the motor generates, the load torque, and the inertia moment ( $GD^2/4$ ). Set a longer accel/decel time when Stall Prevention is enabled. The accel/decel times are lengthened for as long as the Stall Prevention function is operating. For faster acceleration and deceleration, increase the capacity of the drive.

### Compliance with Harmonic Suppression Guidelines

J1000 conforms to strict guidelines in Japan covering harmonic suppression for power conversion devices. Defined in JEM-TR201 and JEM-TR226 and published by the Japan Electrical Manufacturers' Association, these guidelines define the amount of harmonic current output acceptable for new installation. Instructions on calculation harmonic output are available free of charge at [www.e-mechatronics.com](http://www.e-mechatronics.com).

## General Handling

### ■ Wiring Check

Never connect the power supply lines to output terminals U/T1, V/T2, or W/T3. Doing so will destroy the drive. Be sure to perform a final check of all sequence wiring and other connections before turning the power on. Make sure there are no short circuits on the control terminals (+V, AC, etc.), as this could damage the drive.

### ■ Magnetic Contactor Installation

Avoid switching a magnetic contactor on the power supply side more frequently than once every 30 minutes. Frequent switching can cause damage to the drive.

### ■ Inspection and Maintenance

Capacitors in the drive take time to discharge even after the power has been shut off. To prevent shock, wait until the charge LED has gone out before attempting any maintenance on the drive.

The heatsink can become quite hot during operation, and proper precautions should be taken to prevent burns. When replacing the cooling fan, shut off the power and wait at least 15 minutes to be sure that the heatsink has cooled down.

### ■ Transporting the Drive

Never steam clean the drive.

During transport, keep the drive from coming into contact with salts, fluorine, bromine and other such harmful chemicals.

## ● Peripheral Devices

### ■ Installing an MCCB

Install an MCCB to the power supply side of the drive to protect internal circuitry. The type of MCCB needed depends on the power supply power factor (power supply voltage, output frequency, load characteristics, etc.).

Sometimes a fairly large MCCB may be required due to the affects of harmonic current on operating characteristics. Use a leakage breaker that has taken harmonic suppression measures (one designed specifically for drives). The rated current of the leakage breaker must be 30 mA or higher per drive unit. If a leakage breaker faults out without reducing harmonic current, then reduce the carrier frequency of the drive, replace it with a breaker that has better harmonic suppression capabilities, or provide a leakage breaker with at least a 200 mA current rating to each drive unit.

### ■ Magnetic Contactor for Input Power

Even though an MC is designed to switch following a momentary power loss, frequent MC use can damage

other components. Avoid switching the MC more than once every 30 minutes. The MC will not be activated after a momentary power loss if using the operator keypad to run the drive. This is because the drive is unable to restart automatically when set for LOCAL. Although the drive can be stopped by using an MC installed on the power supply side, the drive cannot stop the motor in a controlled fashion, and it will simply coast to stop. If a braking resistor or dynamic braking unit has been installed, be sure to set up a sequence that opens the MC with a thermal protector switch connected to the braking resistor device.

### ■ Magnetic Contactor for Motor

As a general principle, the user should avoid opening and closing the magnetic contactor between the motor and the drive during run. Doing so can cause high peak currents and overcurrent faults. If magnetic contactors are used to bypass the drive by connecting the motor to the power supply directly, make sure to close the bypass only after the drive is stopped and fully disconnected from the motor. The Speed Search function can be used to start a coasting motor.

Use an MC with delayed release if momentary power loss is a concern.

### ■ Motor Thermal Over Load Relay Installation

The drive comes with built in electrothermal protection to prevent damage from overheat. If running several motors from the same drive or if using a multi-pole motor, a thermal relay (THR) should be connected between the drive and each motor. Disable the motor protection selection parameter (L1-01 = 0), and set the thermal relay or thermal protection value in accordance with the data listed on the motor nameplate when running at 50 Hz, and 1.1 times the value listed on the motor nameplate when running at 60 Hz.

### ■ Improving the Power Factor

Installing a DC or AC reactor to the input side of the drive can help improve the power factor.

Refrain from using a capacitor or surge absorber on the output side as a way of improving the power factor, because harmonic contents on the output side can lead to damage from overheat. This can also lead to problems with overcurrent.

### ■ Radio Frequency Interference

Drive output contains harmonic contents that can affect the performance of surrounding electronic instruments such as an AM radio. These problems can be prevented by installing a noise filter, as well as by using a properly grounded metal conduit to separate wiring between the drive and motor.

### ■ Wire Gauges and Wiring Distance

Motor torque can suffer as a result of voltage loss across a long cable running between the drive and motor, especially when there is low frequency output. Make sure that a large enough wire gauge is used.

The optional LED operator requires a proprietary cable to connect to the drive. If an analog signal is used to operate the drive via the input terminals, make sure that the wire between the analog operator and the drive is no longer than 50 m, and that it is properly separated from the main circuit wiring. Use reinforced circuitry (main circuit and relay sequence circuitry) to prevent inductance from surrounding devices. To run the drive with a speed potentiometer via the external terminals, use twisted shielded pair cables and ground the shield.

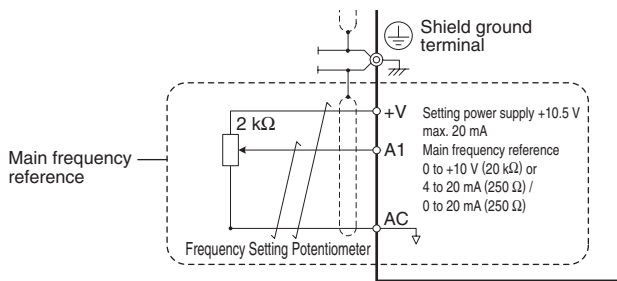

### ■ Counteracting Noise

Because J1000 is designed with PWM control, a low carrier frequency tends to create more motor flux noise than using a higher carrier frequency. Keep the following point in mind when considering how to reduce motor noise:

- Lowering the carrier frequency minimizes the effects of noise.
- A line noise filter can be effective in reducing the affects on AM radio frequencies and poor sensor performance. See "Options and Peripheral Devices" on page 23.
- Make sure the distance between signal and power lines is at least 10 cm (up to 30 cm is preferable), and use twisted pair cable to prevent induction noise from the drive power lines.

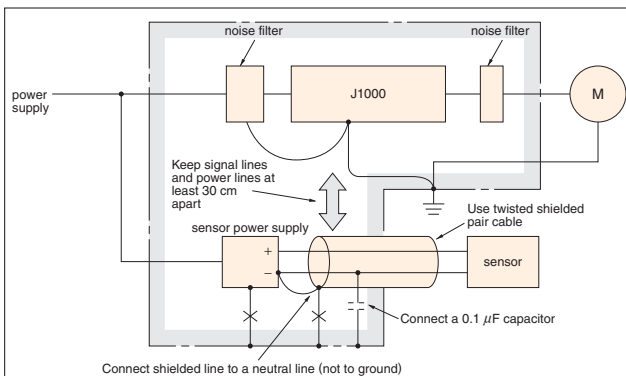

<Provided by JEMA>

### ■ Leakage Current

Harmonic leakage current passes through stray capacitance that exists between the power lines to the drive, ground, and the motor lines. Consider using the following peripheral devices to prevent problems with leakage current.

	Problem	Solution
Ground Leakage Current	MCCB is mistakenly triggered	<ul style="list-style-type: none"> <li>• Lower the carrier frequency set to parameter C6-02.</li> <li>• Try using a component designed to minimize harmonic distortion for the MCCB such as the NV series by Mitsubishi.</li> </ul>
Current Leakage Between Lines	Thermal relay connected to the external terminals is mistakenly triggered by harmonics in the leakage current	<ul style="list-style-type: none"> <li>• Lower the carrier frequency set to parameter C6-02.</li> <li>• Use the drive's built-in thermal motor protection function.</li> </ul>

### Setting the Carrier Frequency Relative to Wiring Distance

Wiring Distance	50 m or less	100 m or less	100 m or more
C6-02:	1 to F	1, 2, 7	1, 7
Carrier Frequency Selection	(15 kHz or less)	(5 kHz or less)	(2 kHz or less)

When a single drive is used to run multiple motors, the length of the motor cable should be calculated as the total distance between the drive and each motor.

## ● Notes on Motor Operation

### Using a Standard Motor

#### ■ Low Speed Range

There is a greater amount of loss when operating a motor using an drive than when running directly from line power. With a drive, the motor can become quite hot due to the poor ability to cool the motor at low speeds. The load torque should be reduced accordingly at low speeds. The figure above shows the allowable load characteristics for a Yaskawa standard motor. A motor designed specifically for operation with a drive should be used when 100% continuous torque is needed at low speeds.

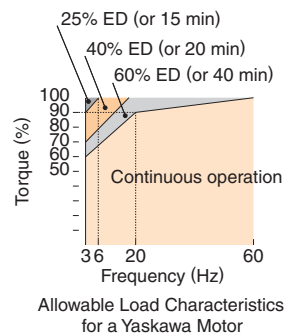

#### ■ Insulation Tolerance

Consider voltage tolerance levels and insulation in applications with an input voltage of over 440 V or particularly long wiring distances. Contact Yaskawa for consultation.

## ■ High Speed Operation

Problems may occur with the motor bearings and dynamic balance in applications operating at over 60 Hz. Contact Yaskawa for consultation.

## ■ Torque Characteristics

Torque characteristics differ when operating directly from line power. The user should have a full understanding of the load torque characteristics for the application.

## ■ Vibration and Shock

J1000 lets the user choose between high carrier PWM control and low carrier PWM. Selecting high carrier PWM can help reduce motor oscillation. Keep the following points in mind when using high carrier PWM:

### (1) Resonance

Take particular caution when using a variable speed drive for an application that is conventionally run from line power at a constant speed. Shock-absorbing rubber should be installed around the base of the motor and the Jump Frequency selection should be enabled to prevent resonance.

### (2) Any imperfection on a rotating body increases vibration with speed.

Caution should be taken when operating above the motor rated speed.

## ■ Audible Noise

Noise created during run varies by the carrier frequency setting. Using a high carrier frequency creates about as much noise as running from line power. Operating above the rated r/min (i.e., above 60 Hz), however, can create unpleasant motor noise.

## ● Applications with Specialized Motors

### ■ Multi-pole Motor

Because the rated current will differ from a standard motor, be sure to check the maximum current when selecting a drive. Always stop the motor before switching between the number of motor poles. If a regen overvoltage fault occurs or if overcurrent protection is triggered, the motor will coast to stop.

### ■ Submersible Motor

Because motor rated current is greater than a standard motor, select the drive capacity accordingly. Be sure to use a large enough motor cable to avoid decreasing the maximum torque level on account of voltage drop caused by a long motor cable.

### ■ Explosion-proof Motor

Both the motor and drive need to be tested together to be certified as explosion-proof. The drive is not for explosion proof areas.

### ■ Geared Motor

Continuous operation specifications differ by the manufacturer of the lubricant. Due to potential problems of gear damage when operating at low speeds, be sure to select the proper lubricant. Consult with the manufacturer for applications that require speeds greater than the rated speed range of the motor or gear box.

### ■ Synchronous Motor

Starting current and rated current are higher for synchronous motors than for standard motors. Contact Yaskawa for the best drive selection when operating a synchronous motor.

### ■ Single-phase Motor

Variable speed drives are not designed for operating single phase motors. Using a capacitor to start the motor causes excessive current to flow into the capacitors, potentially causing damage. A split-phase start or a repulsion start can end up burning out the starter coils because the internal centrifugal switch is not activated. J1000 is for use only with 3-phase motors.

### ■ Uras Vibrator

Uras vibrator is a vibration motor that gets power from centrifugal force by rotating unbalanced weights on both ends of the shaft. Make the following considerations when selecting a drive for use with an Uras vibrator:

(1) Uras vibrator should be used within the drive rated frequency

(2) Increase the acceleration time five to fifteen times longer than would normally be used due to the high amount of load inertia of an Uras vibrator

Note: Contact Yaskawa for applications that require an acceleration time of less than 5 s.

(3) Drive may have trouble starting due to undertorque that results from erratic torque (static friction torque at start)

### ■ Motor with Brake

Caution should be taken when using a drive to operate a motor with a built-in holding brake. If the brake is connected to the output side of the drive, it may not release at start due to low voltage levels. A separate power supply should be installed for the motor brake. Motors with a built-in brake tend to generate a fair amount of noise when running at low speeds.

**Power Driven Machinery (decelerators, belts, chains, etc.)**

Continuous operation at low speeds wears on the lubricating material used in gear box type systems to accelerate and decelerate power driven machinery. Caution should also be taken when operating at speeds above the rated machine speed due to noise and shortened performance life.

# J YASKAWA AC Drive Series

Name	Feature	Capacity Range (kW)				Outline		
		0.1	1	10	100 300			
General Purpose	J1000	Compact V/f Control Drive	Single-Phase 100 V Class*1	0.1	1.1	<ul style="list-style-type: none"> <li>Ultra-small body enables side-by-side installation. Compact design of enclosure panel</li> <li>Easy operation with the Potentiometer Option Unit</li> <li>The noise-suppressing Swing PWM system reduces harsh sound.</li> <li>The full-range fully-automatic torque boost function provides high torque output. (100%/1.5 Hz, 150%/3 Hz)</li> <li>The stall prevention function and the speed search function ensure continuous operation, regardless of load/power supply fluctuations or momentary power loss.</li> <li>The overexcitation braking function enables rapid braking, without using a braking resistor.</li> </ul>		
			Three-Phase 200 V Class	0.1	5.5			
			Single-Phase 200 V Class	0.1	2.2			
			Three-Phase 400 V Class	0.2	5.5			
	V1000	Compact Vector Control Drive	Three-Phase 200 V Class	0.1	18.5		<ul style="list-style-type: none"> <li>Small body and high performance (Current vector control)</li> <li>New technology for driving synchronous motors (IPMM/SPMM) as well as induction motors</li> <li>High starting torque: 200%/0.5 Hz* Torque limit function</li> <li>*: At heavy duty rating, for induction motors with 3.7 kW or lower</li> <li>Application-specific function selection for simplified optimum setup</li> <li>Easy maintenance using the detachable terminal block with the parameter backup function</li> </ul>	
			Single-Phase 200 V Class	0.1	3.7			
			Three-Phase 400 V Class	0.2	18.5			
	Varispeed F7	ADVANCED CURRENT VECTOR CONTROL GENERAL-PURPOSE INVERTER	Three-Phase 200 V Class	0.4	110			<ul style="list-style-type: none"> <li>Open Loop Vector control ensures 150% or higher torque during operation at 0.5 Hz. (Flux Vector Control provides high torque of 150% at zero speed.)</li> <li>Easy maintenance and inspection using the detachable control circuit terminals and the detachable cooling fan</li> <li>PID control and energy-saving control</li> <li>The Auto-Tuning function upgrades all types of general motors to be compatible with high-performance drives.</li> </ul>
Three-Phase 400 V Class			0.4	300				
Varispeed G7	GENERAL-PURPOSE INVERTER WITH ADVANCED VECTOR CONTROL	Three-Phase 200 V Class	0.4	110	<ul style="list-style-type: none"> <li>The 400 V class uses 3-level control for a more perfect output waveform.</li> <li>Open Loop Vector control ensures 150% or higher torque during operation at 0.3 Hz. (Flux Vector Control provides a high torque of 150% at zero speed.)</li> <li>Easy maintenance and inspection using the detachable control circuit terminals and the detachable cooling fan.</li> <li>Software for various applications (for crane, hoist, etc.)</li> <li>The Auto-Tuning function upgrades all types of general motors to be compatible with high-performance drives.</li> </ul>			
		Three-Phase 400 V Class	0.4	300				
Varispeed AC	ENVIRONMENTALLY FRIENDLY MOTOR DRIVES MATRIX CONVERTER	Three-Phase 200 V Class	5.5	45		<ul style="list-style-type: none"> <li>The world's first matrix converter system that outputs AC voltage from AC voltage, and includes power supply regeneration capabilities.</li> <li>The simple, highly-efficient drive can remarkably reduce power supply harmonics, without using peripherals.</li> </ul>		
		Three-Phase 400 V Class	5.5	75*2				
Varispeed F7S	Super Energy-Saving Variable Speed Drive	Three-Phase 200 V Class	0.4	75			<ul style="list-style-type: none"> <li>Enables continuous operation of a synchronous motor (without PG) after momentary power loss, and startup of a coasting synchronous motor (without PG).</li> <li>Enables compact configuration of building air-conditioning system using LONWORKS.</li> </ul>	
		Three-Phase 400 V Class	0.4	300*3				
Special Use	VS-626M5	Three-Phase 200 V Class	5.5	37				<ul style="list-style-type: none"> <li>For multiple-axis drive systems</li> <li>For machine tool spindle drives</li> <li>High-precision, quick-response, high-reliability AC drive system capable of using vector control to run a high-speed AC motor</li> </ul>
		Three-Phase 400 V Class	3.7	45				
	VS-626MR5	Three-Phase 200 V Class	5.5	37				
		Three-Phase 400 V Class	3.7	45				
	VS-626MC5	VECTOR-CONTROLLED INVERTER DRIVES WITH POWER REGENERATIVE FUNCTION FOR MACHINE TOOLS	Three-Phase 200 V Class	0.4	75	<ul style="list-style-type: none"> <li>For machine tool spindle drives</li> <li>Drive system capable of using vector control to run a high-speed AC motor</li> </ul>		
			Three-Phase 400 V Class	0.4	75			
VS-646HF5	High-frequency inverter drives	Three-Phase 200 V Class	2.2	7.5	<ul style="list-style-type: none"> <li>Provides a high rotation speed of 300,000 r/min in combination with a high-speed (2-pole) motor</li> </ul>			

\*1: Single-phase 100 V class for release soon.

\*2: Some models not yet released.

\*3: Up to 160 kW for motors not using a PG encoder.



# Global Service Network



Region	Service Area	Service Location	Service Agency	Telephone/Fax
North America	U.S.A	Chicago (HQ) Los Angeles New Jersey Boston San Francisco Ohio North Carolina	① YASKAWA ELECTRIC AMERICA INC.	Headquarters ☎ +1-847-887-7303 FAX +1-847-887-7070
	Mexico	Mexico City	② PILLAR MEXICANA. S.A. DE C.V.	☎ +52-5593-28-69 FAX +52-5651-55-73
South America	South America	Sao Paulo	③ YASKAWA ELÉCTRICO DO BRASIL LTD.A.	☎ +55-11-3585-1100 FAX +55-11-5581-8795
	Colombia	Santafe De Bogota	④ VARIADORES LTD.A.	☎ +57-91-635-7460 FAX +57-91-611-3872
Europe	All of Europe and South Africa	Frankfurt	⑤ YASKAWA ELECTRIC EUROPE GmbH	☎ +49-6196-569-300 FAX +49-6196-569-398
			⑥ YASKAWA ENGINEERING EUROPE GmbH	☎ +49-6196-569-520 FAX +49-6196-888-598
Asia	Japan	Tokyo, offices nationwide	⑦ YASKAWA ELECTRIC CORPORATION (Manufacturing, sales)	☎ +81-3-5402-4502 FAX +81-3-5402-4580
			⑧ YASKAWA ELECTRIC ENGINEERING CORPORATION (After-sales service)	☎ +81-4-2931-1810 FAX +81-4-2931-1811
	South Korea	Seoul	⑨ YASKAWA ELECTRIC KOREA CORPORATION	☎ +82-2-784-7844 FAX +82-2-784-8495
			⑩ YASKAWA ENGINEERING KOREA Co.	☎ +82-2-3775-0337 FAX +82-2-3775-0338
			⑪ Rockwell Samsung Automation Co., Ltd.	☎ +82-331-200-2981 FAX +82-331-200-2970
	China	Beijing, Guangzhou, Shanghai	⑫ YASKAWA ELECTRIC (SHANGHAI) Co., Ltd.	☎ +86-21-5385-2200 FAX +86-21-5385-3299
	Taiwan	Taipei	⑬ YASKAWA ELECTRIC TAIWAN Co.	☎ +886-2-2502-5003 FAX +886-2-2505-1280
	Singapore	Singapore	⑭ YASKAWA ELECTRIC (SINGAPORE) Pte. Ltd.	☎ +65-6282-3003 FAX +65-6289-3003
			⑮ YASKAWA ENGINEERING ASIA-PACIFIC Pte. Ltd.	☎ +65-6282-1601 FAX +65-6282-3668
	Thailand	Bangkok	⑯ YASKAWA ELECTRIC (THAILAND) Co., Ltd.	☎ +66-2-693-2200 FAX +66-2-693-2204
India	Mumbai	⑰ LARSEN & TOUBRO LIMITED	Headquarters ☎ +91-22-7683511 (662) FAX +91-22-7683525	
Oceania	Australia	Sydney (HQ) Melbourne	⑱ ROBOTIC AUTOMATION Pty. Ltd.	Headquarters ☎ +61-2-9748-3788 FAX +61-2-9748-3817

# J1000

---

**IRUMA BUSINESS CENTER (SOLUTION CENTER)**

480, Kamifujisawa, Iruma, Saitama 358-8555, Japan  
Phone 81-4-2962-5696 Fax 81-4-2962-6138

**YASKAWA ELECTRIC AMERICA, INC.**

2121 Norman Drive South, Waukegan, IL 60085, U.S.A.  
Phone 1-847-887-7000 Fax 1-847-887-7370

**YASKAWA ELÉTRICO DO BRASIL LTDA.**

Avenida Fagundes Filho, 620 São Paulo-SP CEP 04304-000, Brazil  
Phone 55-11-3585-1100 Fax 55-11-5581-8795

**YASKAWA ELECTRIC EUROPE GmbH**

Am Kronberger Hang 2, 65824 Schwalbach, Germany  
Phone 49-6196-569-300 Fax 49-6196-569-312

**YASKAWA ELECTRIC UK LTD.**

1 Hunt Hill Orchardton Woods Cumbernauld, G68 9LF, United Kingdom  
Phone 44-1236-735000 Fax 44-1236-458182

**YASKAWA ELECTRIC KOREA CORPORATION**

7F, Doore Bldg. 24, Yeoido-dong, Youngdungpo-Ku, Seoul 150-877, Korea  
Phone 82-2-784-7844 Fax 82-2-784-8495

**YASKAWA ELECTRIC (SINGAPORE) PTE. LTD.**

151 Lorong Chuan, #04-01, New Tech Park 556741, Singapore  
Phone 65-6282-3003 Fax 65-6289-3003

**YASKAWA ELECTRIC (SHANGHAI) CO., LTD.**

No.18 Xizang Zhong Road, Room 1702-1707, Harbour Ring Plaza Shanghai 200001, China  
Phone 86-21-5385-2200 Fax 86-21-5385-3299

**YASKAWA ELECTRIC (SHANGHAI) CO., LTD. BEIJING OFFICE**

Room 1011A, Tower W3 Oriental Plaza, No.1 East Chang An Ave.,  
Dong Cheng District, Beijing 100738, China  
Phone 86-10-8518-4086 Fax 86-10-8518-4082

**YASKAWA ELECTRIC TAIWAN CORPORATION**

9F, 16, Nanking E. Rd., Sec. 3, Taipei, Taiwan  
Phone 886-2-2502-5003 Fax 886-2-2505-1280



YASKAWA

YASKAWA ELECTRIC CORPORATION

In the event that the end user of this product is to be the military and said product is to be employed in any weapons systems or the manufacture thereof, the export will fall under the relevant regulations as stipulated in the Foreign Exchange and Foreign Trade Regulations. Therefore, be sure to follow all procedures and submit all relevant documentation according to any and all rules, regulations and laws that may apply. Specifications are subject to change without notice for ongoing product modifications and improvements.  
© 2008 YASKAWA ELECTRIC CORPORATION. All rights reserved.

LITERATURE NO. KAEP C710606 24A

Published in Japan March 2008 08-3  
07-11-10



PRINTED WITH SOY INK<sup>TM</sup> Printed on 100% recycled paper with soybean oil ink.